



TEXAS FLANGE

PRODUCT CATALOG: VER 5.00

LOCAL

P 281.484.8325

F 281.484.8730

NATIONAL

P 800.826.3801

F 877.610.8893

WWW.TEXASFLANGE.COM
SALES@TEXASFLANGE.COM



Information in this catalog was compiled from industry sources that Texas Flange & Fitting believes to be reliable. Texas Flange & Fitting Supply, Inc., however, does not guarantee the accuracy of this data.



TEXAS FLANGE

PRODUCT CATALOG: VER 5.00

ANSI B16.5 (1/2"-24")	<i>150 300 400 600 900 1500 2500</i>	-3
ANSI B16.5 Weights	<i>150 300 400 600 900 1500 2500</i>	-10
ANSI B16.5 Flange Tolerances		-13
ANSI B16.5 Bolt and Stud Dimensions		-14
ANSI B16.47 Note & Bolt/Stud Recommendations		-15
ANSI B16.47 Series A - Class 150, 300, 400, 600, 900		-17
ANSI B16.47 Series B - Class 75, 150, 300, 400, 600, 900		-22
B16.47 Modified to Slip On		-28
ANSI B16.1 Industry Standard - Class 125LW, 125SO, 125WN, 250		-31
Boiler Code Flanges - Class 75SO, 75WN, 175, 350		-35
Orifice Union B16.36 - Class 300 WN/SO/Threaded		-41
WN	<i>400 600 900 1500 2500</i>	-44
Jack Screw Sizes for Orifice Flanges		49
AWWA C207 - Class 2B, 2D, 3D, 4E, 5E, 6F		-50
Long Weld Necks - 150, 300, 400, 600, 900, 1500, 2500		-56
Studding Outlets - 150, 300, 600, 900, 1500, 2500		-63
Line Blinds - 150, 300, 600, 900		-69
How to Inquiry a Flange		-73
Wall Thickness and Bore Charts		-74
RTJ Face Dimensions		-76
Alternate Flange Facings		-78



ANSI B16.5 Class 150 Forged Flanges

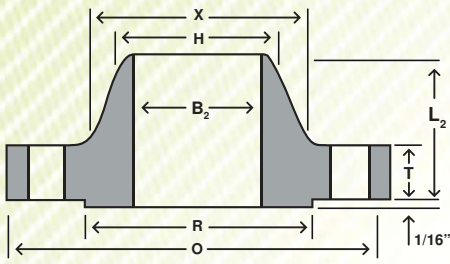

WELD NECK

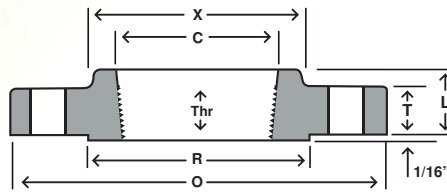

THREADED

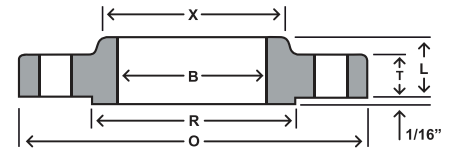

SLIP—ON

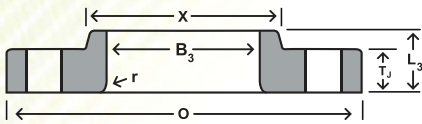

LAP JOINT

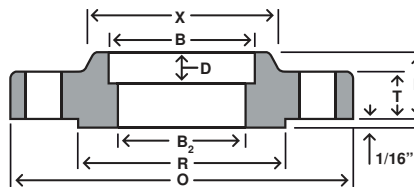

SOCKET WELD

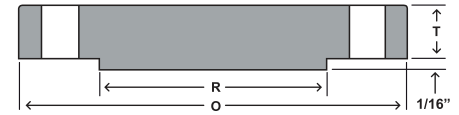

BLIND

Nom. Pipe Size	O	T	T _J	R	X	#/Dia of Holes ^a	Bolt Circle Dia	B	B ₂ ^b	B ₃	H	L	L ₂	L ₃ ^c	r	D	Thr
1/2	3.50	0.38	0.44	1.38	1.19	4-0.62	2.38	0.88	0.62	0.90	0.84	0.56	1.81	0.62	0.12	0.38	0.62
3/4	3.88	0.44	0.50	1.69	1.50	4-0.62	2.75	1.09	0.82	1.11	1.05	0.56	2.00	0.62	0.12	0.44	0.62
1	4.25	0.50	0.56	2.00	1.94	4-0.62	3.12	1.36	1.05	1.38	1.32	0.62	2.12	0.69	0.12	0.50	0.69
1 1/4	4.62	0.56	0.62	2.50	2.31	4-0.62	3.50	1.70	1.38	1.72	1.66	0.75	2.19	0.81	0.19	0.56	0.81
1 1/2	5.00	0.62	0.69	2.88	2.56	4-0.62	3.88	1.95	1.61	1.97	1.90	0.81	2.38	0.88	0.25	0.62	0.88
2	6.00	0.69	0.75	3.62	3.06	4-0.75	4.75	2.44	2.07	2.46	2.38	0.94	2.44	1.00	0.31	0.69	1.00
2 1/2	7.00	0.81	0.88	4.12	3.56	4-0.75	5.50	2.94	2.47	2.97	2.88	1.06	2.69	1.12	0.31	0.75	1.12
3	7.50	0.88	0.94	5.00	4.25	4-0.75	6.00	3.57	3.07	3.60	3.50	1.12	2.69	1.19	0.38	0.81	1.19
3 1/2	8.50	0.88	0.94	5.50	4.81	8-0.75	7.00	4.07	3.55	4.10	4.00	1.19	2.75	1.25	0.38	0.88	1.25
4	9.00	0.88	0.94	6.19	5.31	8-0.75	7.50	4.57	4.03	4.60	4.50	1.25	2.94	1.31	0.44	0.94	1.31
5	10.00	0.88	0.94	7.31	6.44	8-0.88	8.50	5.66	5.05	5.69	5.56	1.38	3.44	1.44	0.44	0.94	1.44
6	11.00	0.94	1.00	8.50	7.56	8-0.88	9.50	6.72	6.07	6.75	6.63	1.50	3.44	1.56	0.50	1.06	1.56
8	13.50	1.06	1.12	10.62	9.69	8-0.88	11.75	8.72	7.98	8.75	8.63	1.69	3.94	1.75	0.50	1.25	1.75
10	16.00	1.12	1.19	12.75	12.00	12-1.00	14.25	10.88	10.02	10.92	10.75	1.88	3.94	1.94	0.50	1.31	1.94
12	19.00	1.19	1.25	15.00	14.38	12-1.00	17.00	12.88	12.00	12.92	12.75	2.12	4.44	2.19	0.50	1.56	2.19
14	21.00	1.31	1.38	16.25	15.75	12-1.12	18.75	14.14	13.25	14.18	14.00	2.19	4.94	3.12	0.50	1.63	2.25
16	23.50	1.38	1.44	18.50	18.00	16-1.12	21.25	16.16	15.25	16.19	16.00	2.44	4.94	3.44	0.50	1.75	2.50
18	25.00	1.50	1.56	21.00	19.88	16-1.25	22.75	18.18	17.25	18.20	18.00	2.62	5.44	3.81	0.50	1.94	2.69
20	27.50	1.62	1.69	23.00	22.00	20-1.25	25.00	20.20	19.25	20.25	20.00	2.81	5.62	4.06	0.50	2.13	2.88
22	29.50	1.75	1.81	25.25	24.25	20-1.38	27.25	22.22	21.25	22.25	22.00	3.07	5.82	4.25	0.50	2.38	3.13
24	32.00	1.81	1.88	27.25	26.12	20-1.38	29.50	24.25	23.25	24.25	24.00	3.19	5.94	4.38	0.50	2.50	3.25

DIMENSIONS ARE IN INCHES

(A) Bolt hole diameter 1/8" larger than bolt diameter

(B) Standard bore dimensions provided. See bore chart for other wall thicknesses

(C) This dimension is commonly associated with "true" lap joints. Industry standard is to make to the slip on length through the hub.



ANSI B16.5 Class 300 Forged Flanges

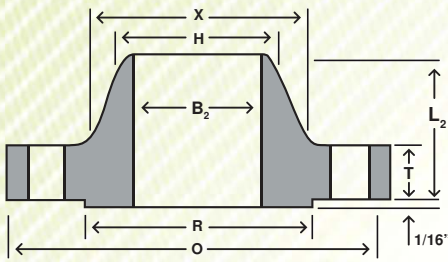

WELD NECK

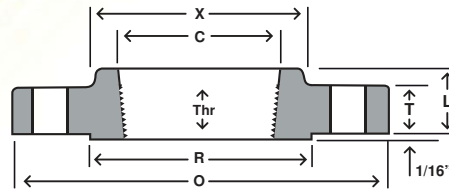

THREADED

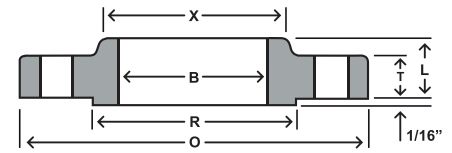

SLIP—ON

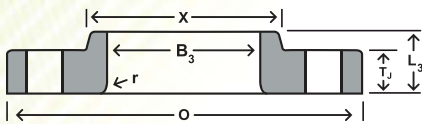

LAP JOINT

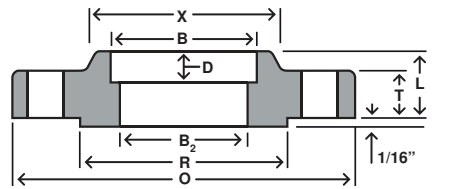

SOCKET WELD

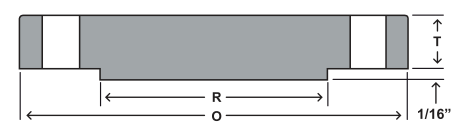

BLIND

Nom. Pipe Size	O	T	T _J	R	X	#/Dia of Holes ^a	Bolt Circle Dia	B	B ₂ ^b	B ₃	H	L	L ₂	L ₃ ^c	r	C	D	Thr
1/2	3.75	0.50	0.56	1.38	1.50	4-0.63	2.62	0.88	0.62	0.90	0.84	0.81	2.00	0.88	0.12	0.93	0.38	0.62
3/4	4.62	0.56	0.62	1.69	1.88	4-0.75	3.25	1.09	0.82	1.11	1.05	0.94	2.19	1.00	0.12	1.14	0.44	0.62
1	4.88	0.62	0.69	2.00	2.12	4-0.75	3.50	1.36	1.05	1.38	1.32	1.00	2.38	1.06	0.12	1.41	0.50	0.69
1 1/4	5.25	0.69	0.75	2.50	2.50	4-0.75	3.88	1.70	1.38	1.72	1.66	1.00	2.50	1.06	0.19	1.75	0.56	0.81
1 1/2	6.12	0.75	0.81	2.88	2.75	4-0.88	4.50	1.95	1.61	1.97	1.90	1.13	2.63	1.19	0.25	1.98	0.62	0.88
2	6.50	0.81	0.88	3.62	3.31	8-0.75	5.00	2.44	2.07	2.46	2.38	1.25	2.69	1.31	0.31	2.50	0.69	1.12
2 1/2	7.50	0.94	1.00	4.12	3.94	8-0.88	5.88	2.94	2.47	2.97	2.88	1.44	2.94	1.50	0.31	3.00	0.75	1.25
3	8.25	1.06	1.12	5.00	4.62	8-0.88	6.62	3.57	3.07	3.60	3.50	1.63	3.06	1.69	0.38	3.63	0.81	1.25
3 1/2	9.00	1.12	1.19	5.50	5.25	8-0.88	7.25	4.07	3.55	4.10	4.00	1.69	3.13	1.75	0.38	4.13	...	1.44
4	10.00	1.19	1.25	6.19	5.75	8-0.88	7.88	4.57	4.03	4.60	4.50	1.82	3.32	1.88	0.44	4.63	...	1.44
5	11.00	1.31	1.38	7.31	7.00	8-0.88	9.25	5.66	5.05	5.69	5.56	1.94	3.82	2.00	0.44	5.69	...	1.69
6	12.50	1.38	1.44	8.50	8.12	12-0.88	10.62	6.72	6.07	6.75	6.63	2.00	3.82	2.06	0.50	6.75	...	1.81
8	15.00	1.56	1.62	10.62	10.25	12-1.00	13.00	8.72	7.98	8.75	8.63	2.38	4.32	2.44	0.50	8.75	...	2.00
10	17.50	1.81	1.88	12.75	12.62	16-1.12	15.25	10.88	10.02	10.92	10.75	2.56	4.56	3.75	0.50	10.88	...	2.19
12	20.50	1.94	2.00	15.00	14.75	16-1.25	17.75	12.88	12.00	12.92	12.75	2.82	5.06	4.00	0.50	12.94	...	2.38
14	23.00	2.06	2.12	16.25	16.75	20-1.25	20.25	14.14	13.25	14.18	14.00	2.94	5.56	4.38	0.50	14.19	...	2.50
16	25.50	2.19	2.25	18.50	19.00	20-1.38	22.50	16.16	15.25	16.19	16.00	3.19	5.69	4.75	0.50	16.19	...	2.69
18	28.00	2.31	2.38	21.00	21.00	24-1.38	24.75	18.18	17.25	18.20	18.00	3.44	6.19	5.12	0.50	18.19	...	2.75
20	30.50	2.44	2.50	23.00	23.12	24-1.38	27.00	20.20	19.25	20.25	20.00	3.69	6.32	5.50	0.50	20.19	...	2.88
22	33.00	2.57	2.63	25.25	25.25	24-1.63	29.25	22.22	21.25	22.25	22.00	3.93	6.43	5.75	0.50	22.19	...	3.13
24	36.00	2.69	2.75	27.25	27.62	24-1.63	32.00	24.25	23.25	24.25	24.00	4.13	6.56	6.00	0.50	24.19	...	3.25

DIMENSIONS ARE IN INCHES

(A) Bolt hole diameter 1/8" larger than bolt diameter

(B) Standard bore dimensions provided. See bore chart for other wall thicknesses

(C) This dimension is commonly associated with "true" lap joints. Industry standard is to make to the slip on length through the hub.



ANSI B16.5 Class 400 Forged Flanges

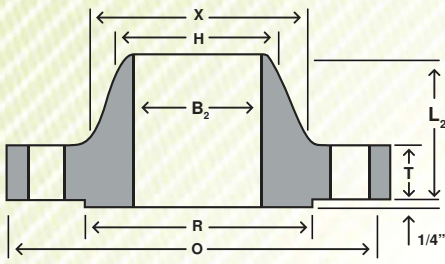

WELD NECK

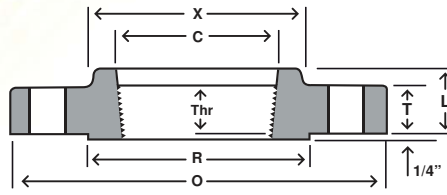

THREADED

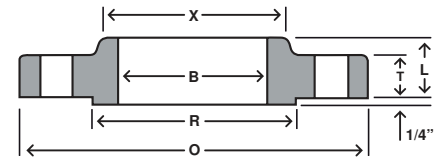

SLIP-ON

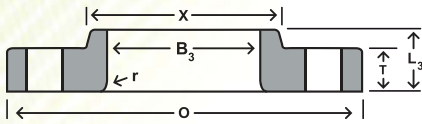

LAP JOINT

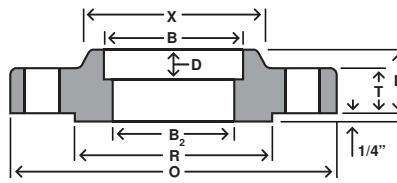

SOCKET WELD

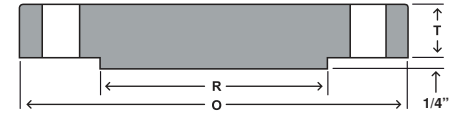

BLIND

Nom. Pipe Size	O	T	R	X	#/Dia of Holes ^a	Bolt Circle Dia	B	B ₂ ^b	B ₃	H	L	L ₂	L ₃ ^c	r	C	D	Thr
1/2	3.75	0.56	1.38	1.50	4-0.63	2.62	0.88		0.90	0.84	0.88	2.06	0.88	0.12	0.93	0.38	0.62
3/4	4.62	0.62	1.69	1.88	4-0.75	3.25	1.09		1.11	1.05	1.00	2.25	1.00	0.12	1.14	0.44	0.62
1	4.88	0.69	2.00	2.12	4-0.75	3.50	1.36		1.38	1.32	1.06	2.44	1.06	0.12	1.41	0.50	0.69
1 1/4	5.25	0.81	2.50	2.50	4-0.75	3.88	1.70		1.72	1.66	1.12	2.62	1.12	0.19	1.75	0.56	0.81
1 1/2	6.12	0.88	2.88	2.75	4-0.88	4.50	1.95		1.97	1.90	1.25	2.75	1.25	0.25	1.99	0.62	0.88
2	6.50	1.00	3.62	3.31	8-0.75	5.00	2.44		2.46	2.38	1.44	2.88	1.44	0.31	2.50	0.69	1.12
2 1/2	7.50	1.12	4.12	3.94	8-0.88	5.88	2.94		2.97	2.88	1.62	3.12	1.62	0.31	3.00	0.75	1.25
3	8.25	1.25	5.00	4.62	8-0.88	6.62	3.57		3.60	3.50	1.81	3.25	1.81	0.38	3.63	0.81	1.38
3 1/2	9.00	1.38	5.50	5.25	8-1.00	7.25	4.07		4.10	4.00	1.94	3.38	1.94	0.38	4.13	1.56
4	10.00	1.38	6.19	5.75	8-1.00	7.88	4.57		4.60	4.50	2.00	3.50	2.00	0.44	4.63	1.44
5	11.00	1.50	7.31	7.00	8-1.00	9.25	5.66		5.69	5.56	2.12	4.00	2.12	0.44	5.69	1.69
6	12.50	1.62	8.50	8.12	12-1.00	10.62	6.72		6.75	6.63	2.25	4.06	2.25	0.50	6.75	1.81
8	15.00	1.88	10.62	10.25	12-1.12	13.00	8.72		8.75	8.63	2.69	4.62	2.69	0.50	8.75	2.00
10	17.50	2.12	12.75	12.62	16-1.25	15.25	10.88		10.92	10.75	2.88	4.88	4.00	0.50	10.88	2.19
12	20.50	2.25	15.00	14.75	16-1.38	17.75	12.88		12.92	12.75	3.12	5.38	4.25	0.50	12.94	2.38
14	23.00	2.38	16.25	16.75	20-1.38	20.25	14.14		14.18	14.00	3.31	5.88	4.62	0.50	14.19	2.50
16	25.50	2.50	18.50	19.00	20-1.50	22.50	16.16		16.19	16.00	3.69	6.00	5.00	0.50	16.19	2.69
18	28.00	2.62	21.00	21.00	24-1.50	24.75	18.18		18.20	18.00	3.88	6.50	5.38	0.50	18.19	2.75
20	30.50	2.75	23.00	23.12	24-1.62	27.00	20.20		20.25	20.00	4.00	6.62	5.75	0.50	20.19	2.88
22	33.00	2.88	25.25	25.25	24-1.75	29.25	22.22		22.25	22.00	4.25	6.75	6.00	0.50	--
24	36.00	3.00	27.25	27.62	24-1.88	32.00	24.25		24.25	24.00	4.50	6.88	6.25	0.50	24.19	3.25

To be specified by Purchaser.

DIMENSIONS ARE IN INCHES

(A) Bolt hole diameter 1/8" larger than bolt diameter

(B) See bore chart for wall thickness

(C) This dimension is commonly associated with "true" lap joints. Industry standard is to make to the slip on length through the hub.



ANSI B16.5 Class 600 Forged Flanges

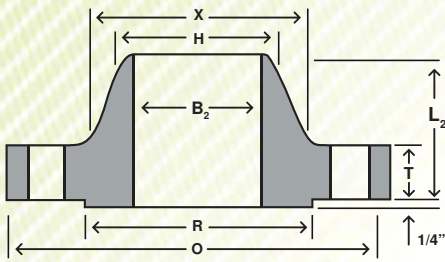

WELD NECK

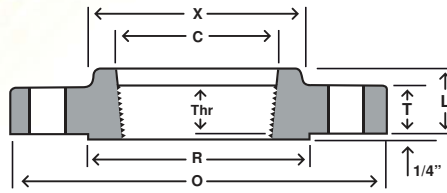

THREADED

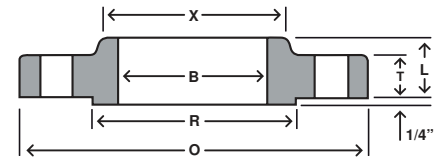

SLIP-ON

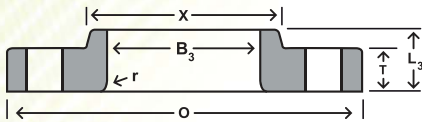

LAP JOINT

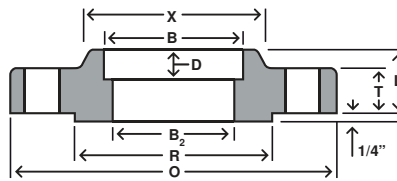

SOCKET WELD

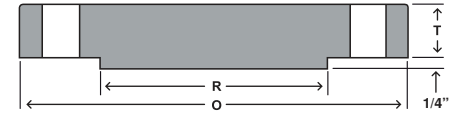

BLIND

Nom. Pipe Size	O	T	R	X	#/Dia of Holes ^a	Bolt Circle Dia	B	B ₂ ^b	B ₃	H	L	L ₂	L ₃ ^c	r	C	D	Thr
1/2	3.75	0.56	1.38	1.50	4-0.63	2.62	0.88		0.90	0.84	0.88	2.06	0.88	0.12	0.93	0.38	0.62
3/4	4.62	0.62	1.69	1.88	4-0.75	3.25	1.09		1.11	1.05	1.00	2.25	1.00	0.12	1.14	0.44	0.62
1	4.88	0.69	2.00	2.12	4-0.75	3.50	1.36		1.38	1.32	1.06	2.44	1.06	0.12	1.41	0.50	0.69
1 1/4	5.25	0.81	2.50	2.50	4-0.75	3.88	1.70		1.72	1.66	1.12	2.62	1.12	0.19	1.75	0.56	0.81
1 1/2	6.12	0.88	2.88	2.75	4-0.88	4.50	1.95		1.97	1.90	1.25	2.75	1.25	0.25	1.99	0.62	0.88
2	6.50	1.00	3.62	3.31	8-0.75	5.00	2.44		2.46	2.38	1.44	2.88	1.44	0.31	2.50	0.69	1.12
2 1/2	7.50	1.12	4.12	3.94	8-0.88	5.88	2.94		2.97	2.88	1.62	3.12	1.62	0.31	3.00	0.75	1.25
3	8.25	1.25	5.00	4.62	8-0.88	6.62	3.57		3.60	3.50	1.81	3.25	1.81	0.38	3.63	0.81	1.38
3 1/2	9.00	1.38	5.50	5.25	8-1.00	7.25	4.07		4.10	4.00	1.94	3.38	1.94	0.38	4.13	1.56
4	10.75	1.50	6.19	6.00	8-1.00	8.50	4.57		4.60	4.50	2.12	4.00	2.12	0.44	4.63	1.62
5	13.00	1.75	7.31	7.44	8-1.12	10.50	5.66		5.69	5.56	2.38	4.50	2.38	0.44	5.69	1.88
6	14.00	1.88	8.50	8.75	12-1.12	11.50	6.72		6.75	6.63	2.62	4.62	2.62	0.50	6.75	2.00
8	16.50	2.19	10.62	10.75	12-1.25	13.75	8.72		8.75	8.63	3.00	5.25	3.00	0.50	8.75	2.25
10	20.00	2.50	12.75	13.50	16-1.38	17.00	10.88		10.92	10.75	3.38	6.00	4.38	0.50	10.88	2.56
12	22.00	2.62	15.00	15.75	20-1.38	19.25	12.88		12.92	12.75	3.62	6.12	4.62	0.50	12.94	2.75
14	23.75	2.75	16.25	17.00	20-1.50	20.75	14.14		14.18	14.00	3.69	6.50	5.00	0.50	14.19	2.88
16	27.00	3.00	18.50	19.50	20-1.63	23.75	16.16		16.19	16.00	4.19	7.00	5.50	0.50	16.19	3.06
18	29.25	3.25	21.00	21.50	20-1.75	25.75	18.18		18.20	18.00	4.62	7.25	6.00	0.50	18.19	3.12
20	32.00	3.50	23.00	24.00	24-1.75	28.50	20.20		20.25	20.00	5.00	7.50	6.50	0.50	20.19	3.25
22	34.25	3.75	25.25	26.25	24-1.75	30.63	22.22		22.25	22.00	5.25	7.75	6.88	0.50	--
24	37.00	4.00	27.25	28.25	24-2.00	33.00	24.25		24.25	24.00	5.50	8.00	7.25	0.50	24.19	3.62

To be specified by Purchaser.

DIMENSIONS ARE IN INCHES

(A) Bolt hole diameter 1/8" larger than bolt diameter

(B) See bore chart for wall thickness

(C) This dimension is commonly associated with "true" lap joints. Industry standard is to make to the slip on length through the hub.



ANSI B16.5 Class 900 Forged Flanges

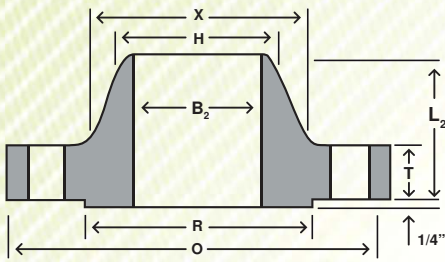

WELD NECK

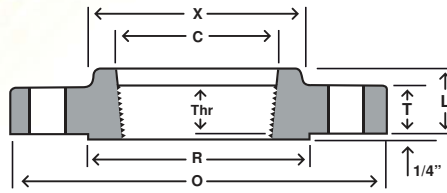

THREADED

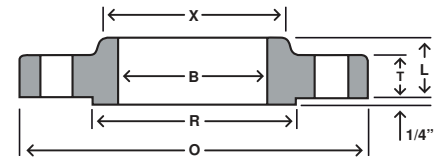

SLIP-ON

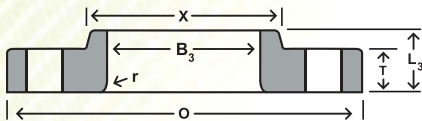

LAP JOINT

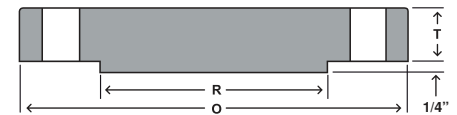

BLIND

Nom. Pipe Size	O	T	R	X	#/Dia of Holes ^a	Bolt Circle Dia	B	B ₂ ^b	B ₃	H	L	L ₂	L ₃ ^c	r	C	Thr
----------------	---	---	---	---	-----------------------------	-----------------	---	-----------------------------	----------------	---	---	----------------	-----------------------------	---	---	-----

Sizes 1/2" through 2 1/2" are identical to class 1500.

Sizes 1/2" through 2 1/2" are identical to class 1500.

3	9.50	1.50	5.00	5.00	8-1.00	7.50	3.57					3.60	3.50	2.12	4.00	2.12	0.38	3.63	1.62
4	11.50	1.75	6.19	6.25	8-1.25	9.25	4.57					4.60	4.50	2.75	4.50	2.75	0.44	4.63	1.88
5	13.75	2.00	7.31	7.50	8-1.38	11.00	5.66					5.69	5.56	3.12	5.00	3.12	0.44	5.69	2.12
6	15.00	2.19	8.50	9.25	12-1.25	12.50	6.72					6.75	6.63	3.38	5.50	3.38	0.50	6.75	2.25
8	18.50	2.50	10.63	11.75	12-1.50	15.50	8.72					8.75	8.63	4.00	6.38	4.50	0.50	8.75	2.50
10	21.50	2.75	12.75	14.50	16-1.50	18.50	10.88					10.92	10.75	4.25	7.25	5.00	0.50	10.88	2.81
12	24.00	3.12	15.00	16.50	20-1.50	21.00	12.88					12.92	12.75	4.63	7.88	5.62	0.50	12.94	3.00
14	25.25	3.38	16.25	17.75	20-1.63	22.00	14.14					14.18	14.00	5.12	8.38	6.12	0.50	14.19	3.25
16	27.75	3.50	18.50	20.00	20-1.75	24.25	16.16					16.19	16.00	5.25	8.50	6.50	0.50	16.19	3.38
18	31.00	4.00	21.00	22.25	20-2.00	27.00	18.18					18.20	18.00	6.00	9.00	7.50	0.50	18.19	3.50
20	33.75	4.25	23.00	24.50	20-2.13	29.50	20.20					20.25	20.00	6.25	9.75	8.25	0.50	20.19	3.62
24	41.00	5.50	27.25	29.50	20-2.63	35.50	24.25					24.25	24.00	8.00	11.50	10.50	0.50	24.19	4.00

To be specified by Purchaser.

DIMENSIONS ARE IN INCHES

(A) Bolt hole diameter 1/8" larger than bolt diameter

(B) See bore chart for wall thickness

(C) This dimension is commonly associated with "true" lap joints. Industry standard is to make to the slip on length through the hub.



ANSI B16.5 Class 1500 Forged Flanges

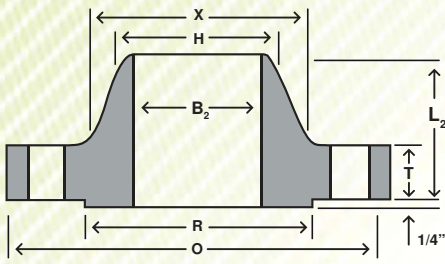

WELD NECK

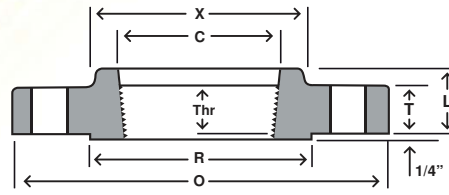

THREADED

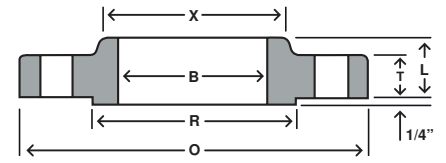

SLIP-ON

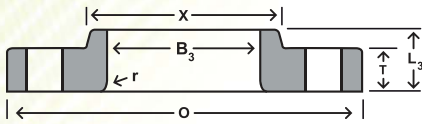

LAP JOINT

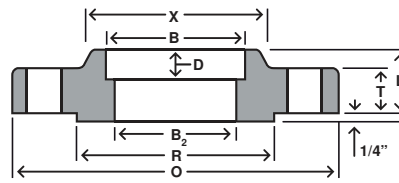

SOCKET WELD

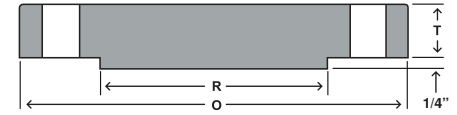

BLIND

Nom. Pipe Size	O	T	R	X	#/Dia of Holes ^a	Bolt Circle Dia	B	B ₂ ^b	B ₃	H	L	L ₂	L ₃ ^c	r	C	D	Thr
1/2	4.75	0.88	1.38	1.50	4-0.88	3.25	0.88		0.90	0.84	1.25	2.38	1.25	0.12	0.93	0.38	0.88
3/4	5.12	1.00	1.69	1.75	4-0.88	3.50	1.09		1.11	1.05	1.38	2.75	1.38	0.12	1.14	0.44	1.00
1	5.88	1.12	2.00	2.06	4-1.00	4.00	1.36		1.38	1.32	1.62	2.88	1.62	0.12	1.41	0.50	1.12
1 1/4	6.25	1.12	2.50	2.50	4-1.00	4.38	1.70		1.72	1.66	1.62	2.88	1.62	0.19	1.75	0.56	1.19
1 1/2	7.00	1.25	2.88	2.75	4-1.12	4.88	1.95		1.97	1.90	1.75	3.25	1.75	0.25	1.99	0.62	1.25
2	8.50	1.50	3.63	4.12	8-1.00	6.50	2.44		2.46	2.38	2.25	4.00	2.25	0.31	2.50	0.69	1.50
2 1/2	9.62	1.62	4.13	4.88	8-1.12	7.50	2.94		2.97	2.88	2.50	4.12	2.50	0.31	3.00	0.75	1.88
3	10.50	1.88	5.00	5.25	8-1.25	8.00	...		3.60	3.50	...	4.62	2.88	0.38
4	12.25	2.12	6.19	6.38	8-1.38	9.50	...		4.60	4.50	...	4.88	3.56	0.44
5	14.75	2.88	7.31	7.75	8-1.63	11.50	...		5.69	5.56	...	6.12	4.12	0.44
6	15.50	3.25	8.50	9.00	12-1.50	12.50	...		6.75	6.63	...	6.75	4.69	0.50
8	19.00	3.62	10.63	11.50	12-1.75	15.50	...		8.75	8.63	...	8.38	5.62	0.50
10	23.00	4.25	12.75	14.50	12-2.00	19.00	...		10.92	10.75	...	10.00	7.00	0.50
12	26.50	4.88	15.00	17.75	16-2.12	22.50	...		12.92	12.75	...	11.12	8.62	0.50
14	29.50	5.25	16.25	19.50	16-2.38	25.00	...		14.18	14.00	...	11.75	9.50	0.50
16	32.50	5.75	18.50	21.75	16-2.63	27.75	...		16.19	16.00	...	12.25	10.25	0.50
18	36.00	6.38	21.00	23.50	16-2.88	30.50	...		18.20	18.00	...	12.88	10.88	0.50
20	38.75	7.00	23.00	25.25	16-3.12	32.75	...		20.25	20.00	...	14.00	11.50	0.50
24	46.00	8.00	27.25	30.00	16-3.63	39.00	...		24.25	24.00	...	16.00	13.00	0.50

To be specified by Purchaser.

DIMENSIONS ARE IN INCHES

(A) Bolt hole diameter 1/8" larger than bolt diameter

(B) See bore chart for wall thickness

(C) This dimension is commonly associated with "true" lap joints. Industry standard is to make to the slip on length through the hub.



ANSI B16.5 Class 2500 Forged Flanges

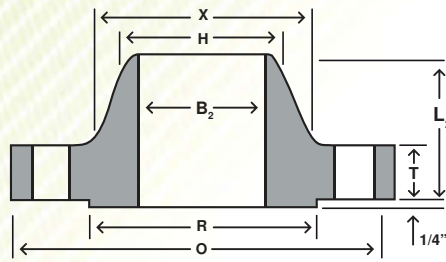

WELD NECK

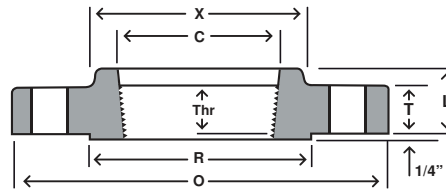

THREADED

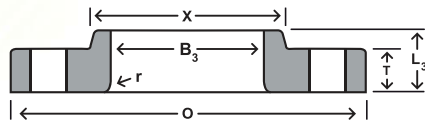

LAP JOINT

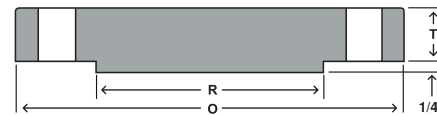

BLIND

Nom. Pipe Size	O	T	R	X	#/Dia of Holes ^a	Bolt Circle Dia	B ₂ ^b	B ₃	H	L	L ₂	L ₃	r	C	Thr
1/2	5.25	1.19	1.38	1.69	4-0.88	3.50		0.90	0.84	1.56	2.88	1.56	0.12	0.93	1.12
3/4	5.50	1.25	1.69	2.00	4-0.88	3.75		1.11	1.05	1.69	3.12	1.69	0.12	1.14	1.25
1	6.25	1.38	2.00	2.25	4-1.00	4.25		1.38	1.32	1.88	3.50	1.88	0.12	1.41	1.38
1 1/4	7.25	1.50	2.50	2.88	4-1.12	5.13		1.72	1.66	2.06	3.75	2.06	0.19	1.75	1.50
1 1/2	8.00	1.75	2.88	3.12	4-1.25	5.75		1.97	1.90	2.38	4.38	2.38	0.25	1.99	1.75
2	9.25	2.00	3.63	3.75	8-1.12	6.75		2.46	2.38	2.75	5.00	2.75	0.31	2.50	2.00
2 1/2	10.50	2.25	4.13	4.50	8-1.25	7.75		2.97	2.88	3.12	5.62	3.12	0.31	3.00	2.25
3	12.00	2.62	5.00	5.25	8-1.38	9.00		3.60	3.50	6.62	3.62	0.38
4	14.00	3.00	6.19	6.50	8-1.63	10.75		4.60	4.50	7.50	4.25	0.44
5	16.50	3.62	7.31	8.00	8-1.88	12.75		5.69	5.56	9.00	5.12	0.44
6	19.00	4.25	8.50	9.25	8-2.12	14.50		6.75	6.63	10.75	6.00	0.50
8	21.75	5.00	10.63	12.00	12-2.12	17.25		8.75	8.63	12.50	7.00	0.50
10	26.50	6.50	12.75	14.75	12-2.63	21.25		10.92	10.75	16.50	9.00	0.50
12	30.00	7.25	15.00	17.38	12-2.88	24.38		12.92	12.75	18.25	10.00	0.50

To be specified by Purchaser.

DIMENSIONS ARE IN INCHES

- (A) Bolt hole diameter 1/8" larger than bolt diameter
- (B) See bore chart for wall thickness
- (C) This dimension is commonly associated with "true" lap joints. Industry standard is to make to the slip on length through the hub.
- (D) Slip On's and Socket Welds are not included in ASME/ANSI code for 2500# Class.
- (E) Sizes larger than 12" in 2500# can be quoted, but we would require a drawing to be supplied.



ANSI B16.5 – 1/2” – 24” Forged Flanges

APPROXIMATE WEIGHT LIST (LBS)

CLASS	Nominal Pipe Size	Slip On	Threaded	Socket Weld	Lap Joint	Blind	Weld Neck	
150 lb	1/2	1	1	2	1	2	2	
	3/4	2	2	2	2	2	2	
	1	2	2	2	2	2	3	
	1 1/4	3	3	3	3	3	3	
	1 1/2	3	3	3	3	4	4	
	2	5	5	5	5	5	6	
	2 1/2	8	8	8	8	7	10	
	3	9	9	9	9	9	11.5	
	3 1/2	11	12	11	11	13	12	
	4	13	13	13	13	17	16.5	
	5	15	15	15	15	20	21	
	6	19	19	19	19	27	26	
	8	30	30	30	30	47	42	
	10	43	43	43	43	70	54	
	12	64	64	64	64	123	88	
	14	90	90	90	105	140	114	
	16	106	98	98	140	180	140	
	18	130	130	130	160	220	165	
	20	165	165	165	195	285	197	
	22	185	185	185	245	355	225	
	24	220	220	220	275	430	268	
	300 lb	1/2	2	2	3	2	2	2
		3/4	3	3	3	3	3	3
		1	3	3	3	3	4	4
1 1/4		4.5	4.5	4	4.5	6	5	
1 1/2		6.5	6.5	6	6.5	7	7	
2		7	7	7	7	8	9	
2 1/2		10	10	10	10	12	12	
3		13	14	13	14.5	16	18	
3 1/2		17	17	17	17	21	20	
4		23.5	24	22	24	28	26.5	
5		29	31	28	28	37	36	
6		39	39	39	39	50	45	
8		58	58	58	58	81	69	
10		81	81	81	91	124	100	
12		115	115	115	140	185	142	
14		165	165	165	190	250	206	
16		210	220	190	234	315	250	
18		253	280	250	305	414	320	
20		315	325	315	375	515	400	
22		370	370	370	435	640	465	
24		490	490	475	550	800	580	



ANSI B16.5 – 1/2” – 24” Forged Flanges

APPROXIMATE WEIGHT LIST (LBS) CONT.

CLASS	Nominal Pipe Size	Slip On	Threaded	Socket Weld	Lap Joint	Blind	Weld Neck	
400 lb	1/2	2	2	2	2	2	3	
	3/4	3	3	3	3	3	3.5	
	1	3.5	3.5	3.5	3.5	4	4	
	1 1/4	4.5	4.5	4.5	4.5	6	4.5	
	1 1/2	6.5	6.5	6.5	6.5	8	8	
	2	8	8	8	8	10	10	
	2 1/2	12	12	12	11	15	14	
	3	15	15	15	14	20	18	
	3 1/2	21	21	21	20	29	26	
	4	26	26	26	25	33	35	
	5	31	31	31	29	44	43	
	6	44	44	44	42	61	57	
	8	67	67	67	64	100	89	
	10	91	91	91	110	155	125	
	12	130	130	130	152	226	175	
	14	191	191	191	210	310	233	
	16	253	253	253	280	398	295	
	18	310	310	310	345	502	360	
	20	378	378	378	420	621	445	
	22	405	405	405	455	720	505	
	24	539	539	539	615	936	640	
	600 lb	1/2	2	2	2	2	3	3
		3/4	3	3	3	3	4	4
		1	4	4	4	4	4	4
1 1/4		5	5	5	5	6	6	
1 1/2		7	7	7	7	8	8	
2		9	9	9	9	10	12	
2 1/2		13	13	13	12	15	18	
3		16	16	16	15	20	23	
3 1/2		21	21	21	20	29	26	
4		37	37	37	36	41	42	
5		63	63	63	63	68	68	
6		80	80	80	78	86	81	
8		115	15	15	112	140	120	
10		177	177	177	195	231	190	
12		215	215	215	240	295	226	
14		259	259	259	290	378	347	
16		366	366	366	400	527	481	
18		476	476	476	469	665	555	
20		612	612	612	604	855	690	
22		590	590	590	670	1000	720	
24		876	876	876	866	1250	977	



ANSI B16.5 – 1/2”–24” Forged Flanges

APPROXIMATE WEIGHT LIST (LBS) CONT.

CLASS	Nominal Pipe Size	Slip On	Threaded	Socket Weld	Lap Joint	Blind	Weld Neck
900 lb	1/2	6	6	6	6	4	7
	3/4	6	6	6	6	6	7
	1	7.5	7.5	7.5	7.5	9	8.5
	1 1/4	10	10	10	10	10	10
	1 1/2	14	14	14	14	14	14
	2	22	22	22	21	25	24
	2 1/2	31	31	31	25	32	31
	3	36	36	36	29	35	36
	4	53	53	53	51	54	53
	5	83	83	83	81	87	86
	6	110	110	110	105	115	110
	8	172	172	172	190	200	187
	10	245	245	245	277	290	268
	12	326	326	326	371	415	372
	14	400	400	400	415	520	562
	16	459	459	459	488	619	685
18	647	647	647	670	880	924	
20	792	792	792	868	1107	1164	
24	1480	1480	1480	1659	2099	2107	
1500 lb	1/2	6	6	6	6	4	7
	3/4	6	6	6	6	6	7
	1	8	8	8	8	9	9
	1 1/4	10	10	10	10	10	10
	1 1/2	14	14	14	14	14	14
	2	25	25	25	25	25	25
	2 1/2	36	36	36	35	35	36
	3	48	48	48	47	48	48
	4	73	73	73	75	73	73
	5	132	132	132	140	140	132
	6	165	165	165	170	160	165
	8	260	260	260	286	302	275
	10	436	436	436	485	510	455
	12	667	667	667	749	775	690
	14	940	940	940	890	975	940
	16	1250	1250	1250	1250	1300	1250
18	1625	1625	1625	1475	1750	1625	
20	2050	2050	2050	1775	2225	2050	
24	2825	2825	2825	2825	3625	3325	
2500 lb	1/2	7	7	7	8
	3/4	9	8	10	9
	1	12	12	12	13
	1 1/4	18	17	18	20
	1 1/2	25	24	25	28
	2	38	37	39	42
	2 1/2	55	53	56	52
	3	83	80	86	94
	4	127	122	133	146
	5	210	204	223	244
	6	323	314	345	378
	8	485	471	533	576
10	925	897	1025	1068	
12	1300	1262	1464	1608	



Dimensional Tolerances B16.5-2003

THREADED | SOCKET WELD SLIP ON | LAP JOINT | BLIND

Outside Diameter (1)	when the O.D. is 24" or less	$\pm 1/16"$
	when the O.D. is over 24"	$\pm 1/8"$
Inside Diameter	Threaded	within limits on boring gauge
	Socket-Welding, Slip-On and Lap-Joint	$\leq 10" + 1/32", -0"$ $\geq 12" + 1/16", -0"$
Outside Diameter of Hub (1)	$\leq 12"$	$+3/32"$ $-1/16"$
	$\geq 14"$	$\pm 1/8"$
Diameter of Contact Face	1/16" Raised Face	$\pm 1/32"$
	1/4" Raised Face Tongue & Groove Male, Female	$\pm 1/64"$
Diameter of Counterbore	Same as for Inside diameter	
Drilling	Bolt Circle	$\pm 1/16"$
	Bolt Hole Spacing	$\pm 1/32"$
	Concentricity of Bolt Circle with Respect to Facing	NPS $\leq 2 1/2"$ $1/32"$ max NPS $\geq 3"$ $1/16"$ max
Thickness	$\leq 18"$	$+1/8", -0"$
	$\geq 20"$	$+3/16", -0"$
Length Through the Hub (1)	$\leq 18"$	$+1/8", -1/32"$
	$\geq 20"$	$+3/16", -1/16"$

WELD NECK

Outside Diameter (1)	when the O.D. is 24" or less	$\pm 1/16"$
	when the O.D. is over 24"	$\pm 1/8"$
Inside Diameter	$\leq 10"$	$\pm 1/32"$
	12" through 18"	$\pm 1/16"$
	$\geq 20"$	$+1/8"$ $-1/16"$
Diameter of Contact Face	1/16" Raised Face	$\pm 1/32"$
	1/4" Raised Face Tongue & Groove Male, Female	$\pm 1/64"$
Diameter of Hub at Base (1)	when Hub Base is 24" or less	$+1/16"$
	when Hub Base is over 24"	$\pm 1/8"$
Diameter of Hub at Point of Welding	NPS $\leq 5"$	$+3/32"$ $-1/32"$
	NPS $\geq 6"$	$+5/32"$ $1/32"$
Drilling	Bolt Circle	$\pm 1/16"$
	Bolt Hole Spacing	$\pm 1/32"$
	Concentricity of Bolt Circle with Respect to Facing	NPS $\leq 2 1/2"$ $1/32"$ max NPS $\geq 3"$ $1/16"$ max
Thickness	$\leq 18"$	$+1/8", -0"$
	$\geq 20"$	$+3/16", -0"$
Length Through the Hub	NPS $\leq 4"$	$\pm 1/16"$
	$5 \leq \text{NPS} \leq 10"$	$+1/16", -1/8"$
	$\geq 12"$	$+1/8", -3/16"$

WELDING BEVEL STANDARDS

For wall thickness "t" 3/16" to 3/4" included

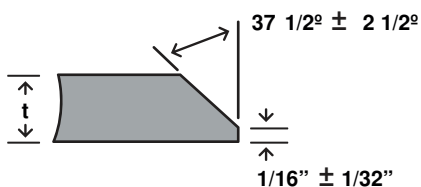

For wall thickness "t" greater than 3/4"

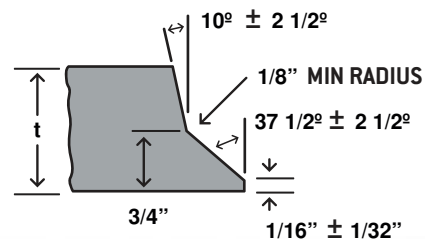

[1] Tolerances not listed in B16.5-2003

Bolt and Stud Dimensions

ASME B16.5

Nominal Pipe Size	150 LB. Flanges				300 LB. Flanges				600 LB. Flanges			
	# Bolts or Studs	Dia of Bolts or Studs	Length of Stud		# Bolts or Studs	Dia of Bolts or Studs	Length of Stud		# Bolts or Studs	Dia of Bolts or Studs	Length of Stud	
			1/16 RF	RTJ			1/16 RF	RTJ			1/4 RF	RTJ
1/2	4	0.50	2-1/4	-	4	0.50	2-1/2	3	4	0.50	3	3
3/4	4	0.50	2-1/2	-	4	0.63	3	3-1/2	4	0.63	3-1/2	3-1/2
1	4	0.50	2-1/2	3	4	0.63	3	3-1/2	4	0.63	3-1/2	3-1/2
1-1/4	4	0.50	2-3/4	3-1/4	4	0.63	3-1/4	3-3/4	4	0.63	3-3/4	3-3/4
1-1/2	4	0.50	2-3/4	3-1/4	4	0.75	3-1/2	4	4	0.75	4-1/4	4-1/4
2	4	0.63	3-1/4	3-3/4	8	0.63	3-1/2	4	8	0.63	4-1/4	4-1/4
2-1/2	4	0.63	3-1/2	4	8	0.75	4	4-1/2	8	0.75	4-3/4	4-3/4
3	4	0.63	3-1/2	4	8	0.75	4-1/4	4-3/4	8	0.75	5	5
3-1/2	8	0.63	3-1/2	4	8	0.75	4-1/4	5	8	0.88	5-1/2	5-1/2
4	8	0.63	3-1/2	4	8	0.75	4-1/2	5	8	0.88	5-3/4	5-3/4
5	8	0.75	3-3/4	4-1/4	8	0.75	4-3/4	5-1/4	8	1.00	6-1/2	6-1/2
6	8	0.75	4	4-1/2	12	0.75	4-3/4	5-1/2	12	1.00	6-3/4	6-3/4
8	8	0.75	4-1/4	4-3/4	12	0.88	5-1/2	6	12	1.13	7-1/2	7-3/4
10	12	0.88	4-1/2	5	16	1.00	6-1/4	6-3/4	16	1.25	8-1/2	8-1/2
12	12	0.88	4-3/4	5-1/4	16	1.13	6-3/4	7-1/4	20	1.25	8-3/4	8-3/4
14	12	1.00	5-1/4	5-3/4	20	1.13	7	7-1/2	20	1.38	9-1/4	9-1/4
16	16	1.00	5-1/4	5-3/4	20	1.25	7-1/2	8	20	1.50	10	10
18	16	1.13	5-3/4	6-1/4	24	1.25	7-3/4	8-1/4	20	1.63	10-3/4	10-3/4
20	20	1.13	6-1/4	6-3/4	24	1.25	8	8-3/4	24	1.63	11-1/4	11-1/2
24	20	1.25	6-3/4	7-1/4	24	1.50	9	10	24	1.88	13	13-1/4

Nominal Pipe Size	900 LB. Flanges				1500 LB. Flanges				2500 LB. Flanges			
	# Bolts or Studs	Dia of Bolts or Studs	Length of Stud		# Bolts or Studs	Dia of Bolts or Studs	Length of Stud		# Bolts or Studs	Dia of Bolts or Studs	Length of Stud	
			1/4 RF	RTJ			1/4 RF	RTJ			1/4 RF	RTJ
1/2	4	0.75	4-1/4	4-1/4	4	0.75	4-1/4	4-1/4	4	0.75	4-3/4	4-3/4
3/4	4	0.75	4-1/2	4-1/2	4	0.75	4-1/2	4-1/2	4	0.75	5	5
1	4	0.88	5	5	4	0.88	5	5	4	0.88	5-1/2	5-1/2
1-1/4	4	0.88	5	5	4	0.88	5	5	4	1.00	6	6
1-1/2	4	1.00	5-1/2	5-1/2	4	1.00	5-1/2	5-1/2	4	1.13	6-3/4	6-3/4
2	8	0.88	5-3/4	5-3/4	8	0.88	5-3/4	5-3/4	8	1.00	7	7
2-1/2	8	1.00	6-1/4	6-1/4	8	1.00	6-1/4	6-1/4	8	1.13	7-3/4	8
3	8	0.88	5-3/4	5-3/4	8	1.13	7	7	8	1.25	8-3/4	9
4	8	1.13	6-3/4	6-3/4	8	1.25	7-3/4	7-3/4	8	1.50	10	10-1/4
5	8	1.25	7-1/2	7-1/2	8	1.50	9-3/4	9-3/4	8	1.75	11-3/4	12-1/4
6	12	1.13	7-1/2	7-3/4	12	1.38	10-1/4	10-1/2	8	2.00	13-1/2	14
8	12	1.38	8-3/4	8-3/4	12	1.63	11-1/2	12-3/4	12	2.00	15	15-1/2
10	16	1.38	9-1/4	9-1/4	12	1.88	13-1/4	13-1/2	12	2.50	19-1/4	20
12	20	1.38	10	10	16	2.00	14-3/4	15-1/4	12	2.75	21-1/4	22
14	20	1.50	10-3/4	11	16	2.25	16	16-3/4	-	-	-	-
16	20	1.63	11-1/4	11-1/2	16	2.50	17-1/2	18-1/2	-	-	-	-
18	20	1.88	12-3/4	13-1/4	16	2.75	19-1/2	20-3/4	-	-	-	-
20	20	2.00	13-3/4	14-1/4	16	3.00	21-1/4	22-1/4	-	-	-	-
24	20	2.50	17-1/4	18	16	3.50	24-1/4	25-1/2	-	-	-	-

DIMENSIONS ARE IN INCHES



A Quick Note on B16.47

ASME has incorporated most of the MSS-SP44 specification into B16.47 Series A and most of the API 605 specification into B16.47 Series B. They have also added Blind Flanges to these two specs. You may note that either spec only includes Weld Necks and Blinds.

For Slip On's over 24", please specify one of the following:

- a. Industry standard per B16.1 dims (125LW, 125/150, 250)
- b. AWWA C207 (Rings or Hubs and Class B, D, E, or F)
- c. Boiler code flanges (75#, 175#, 350#)
- d. SO to Ser A or Ser B dims. We have now included these dimensions on pp 28-30.

For a more detailed explanation of large diameter slip on's please see the FAQ page at www.texasflange.com.

If you need help deciding which flange best suits your application, feel free to contact us.



Bolt and Stud Recommendations per ASME B16.47

	Carbon Steel	Other Materials
Stud-bolts	AMSE B18.2.1	
Bolts	AMSE B18.2.1, square or heavy hex head	AMSE B18.2.1, square or heavy hex head
Nuts smaller than 3/4" Nuts equal to or larger than 3/4"	ASME/ASME B18.2.2., heavy hex	
	ASME/AMSE B18.2.2, hex or heavy hex	ASME/ASME B18.2.2, heavy hex
Male Threads	ASME B1.1, Cl. 2A coarse series	ASME B1.1, Cl. 2A coarse series up through 1" bolts, 8 thread series for larger bolts
Female Threads	ASME B1.1, Cl. 2B coarse series	ASME B1.1, Cl. 2B coarse series up through 1" bolts, 8 thread series for larger bolts



B16.47 Series A Class 150 Weld Neck & Blind

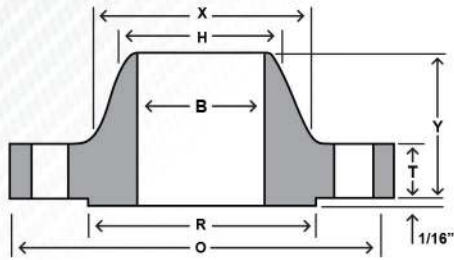

WELD NECK



BLIND

Nom Size	Thickness			Drilling									Weight	
	OD	Weld Neck	Blind	OD of RF	Dia at Base	Bore	LTH	Dia Bevel	Bolt Circle	Bolt Length	Hole Dia	# of Holes	Weld Neck	Blind
	O	T	T	R	X	B	Y	H		(A)	(B)			
26	34.25	2.63	2.63	29.50	26.62		4.69	26.00	31.75	8.75	1.38	24	300	702
28	36.50	2.75	2.75	31.50	28.62		4.88	28.00	34.00	9.00	1.38	28	345	833
30	38.75	2.88	2.88	33.75	30.75		5.32	30.00	36.00	9.25	1.38	28	400	982
32	41.75	3.13	3.13	36.00	32.75		5.63	32.00	38.50	10.50	1.62	28	505	1237
34	43.75	3.19	3.19	38.00	34.75		5.82	34.00	40.50	10.50	1.62	32	540	1384
36	46.00	3.50	3.50	40.25	36.75		6.13	36.00	42.75	11.00	1.62	32	640	1676
38	48.75	3.38	3.38	42.25	39.00		6.13	38.00	45.25	11.00	1.62	32	720	1819
40	50.75	3.50	3.50	44.25	41.00		6.38	40.00	47.25	11.00	1.62	36	775	2040
42	53.00	3.75	3.75	47.00	43.00		6.69	42.00	49.50	11.50	1.62	36	890	2381
44	55.25	3.94	3.94	49.00	45.00		6.94	44.00	51.75	12.00	1.62	40	990	2717
46	57.25	4.00	4.00	51.00	47.12		7.25	46.00	53.75	12.00	1.62	40	1060	2961
48	59.50	4.19	4.19	53.50	49.12		7.50	48.00	56.00	12.50	1.62	44	1185	3348
50	61.75	4.32	4.32	55.50	51.25		7.94	50.00	58.25	13.25	1.88	44	1270	3716
52	64.00	4.50	4.50	57.50	53.25		8.19	52.00	60.50	13.75	1.88	44	1410	4156
54	66.25	4.69	4.69	59.50	55.25		8.44	54.00	62.75	14.00	1.88	44	1585	4639
56	68.75	4.82	4.82	62.00	57.38		8.94	56.00	65.00	14.25	1.88	48	1760	5132
58	71.00	5.00	5.00	64.00	59.38		9.19	58.00	67.25	14.75	1.88	48	1915	5675
60	73.00	5.13	5.13	66.00	61.38		9.38	60.00	69.25	15.00	1.88	52	2045	6154

To be specified by Purchaser.

DIMENSIONS ARE IN INCHES | WEIGHTS ARE IN POUNDS

(A) Bolt lengths are calculated based on bolting one WN to one Blind

(B) Bolt diameter should be 1/8" less than the bolt hole diameter

(C) Larger sizes as well as intermediate sizes can be furnished



B16.47 Series A Class 300 Weld Neck & Blind

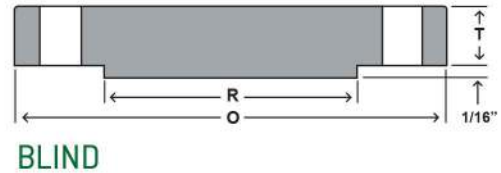
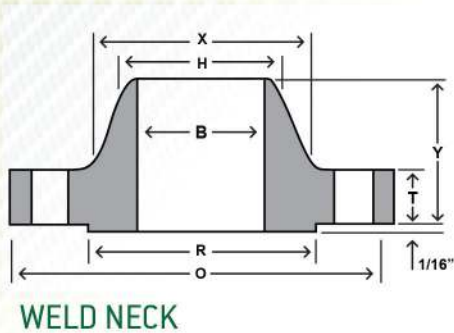

Nom Size	Thickness			Drilling									Weight	
	OD	Weld Neck	Blind	OD of RF	Dia at Base	Bore	LTH	Dia Bevel	Bolt Circle	Bolt Length	Hole Dia	# of Holes	Weld Neck	Blind
	O	T	T	R	X	B	Y	H		(A)	(B)			
26	38.25	3.07	3.25	29.50	28.38		7.19	26.00	34.50	10.75	1.75	28	605	1078
28	40.75	3.32	3.50	31.50	30.50		7.69	28.00	37.00	11.25	1.75	28	745	1315
30	43.00	3.57	3.69	33.75	32.56		8.19	30.00	39.25	12.00	1.88	28	870	1543
32	45.25	3.82	3.88	36.00	34.69		8.69	32.00	41.50	12.50	2.00	28	1005	1795
34	47.50	3.94	4.07	38.00	36.88		9.07	34.00	43.50	13.00	2.00	28	1145	2068
36	50.00	4.07	4.32	40.25	39.00		9.44	36.00	46.00	13.50	2.12	32	1275	2436
38	46.00	4.19	4.19	40.50	39.12		7.06	38.00	43.00	12.50	1.62	32	695	2001
40	48.75	4.44	4.44	42.75	41.25		7.56	40.00	45.50	13.25	1.75	32	840	2380
42	50.75	4.63	4.63	44.75	43.25		7.82	42.00	47.50	13.75	1.75	32	950	2688
44	53.25	4.82	4.82	47.00	45.25		8.06	44.00	49.75	14.25	1.88	32	1055	3079
46	55.75	5.00	5.00	49.00	47.38		8.44	46.00	52.00	15.00	2.00	28	1235	3499
48	57.75	5.19	5.19	51.25	49.38		8.75	48.00	54.00	15.25	2.00	32	1380	3896
50	60.25	5.44	5.44	53.50	51.38		9.07	50.00	56.25	16.00	2.12	32	1530	4442
52	62.25	5.63	5.63	55.50	53.38		9.32	52.00	58.25	16.50	2.12	32	1660	4906
54	65.25	5.94	5.94	57.75	55.50		9.88	54.00	61.00	17.50	2.38	28	2050	5684
56	67.25	6.00	6.00	59.75	57.62		10.19	56.00	63.00	17.75	2.38	28	2155	6098
58	69.25	6.19	6.19	62.00	59.62		10.44	58.00	65.00	18.00	2.38	32	2270	6669
60	71.25	6.38	6.38	64.00	61.62		10.69	60.00	67.00	18.50	2.38	32	2470	7274

To be specified by Purchaser.

DIMENSIONS ARE IN INCHES | WEIGHTS ARE IN POUNDS

(A) Bolt lengths are calculated based on bolting one WN to one Blind

(B) Bolt diameter should be 1/8" less than the bolt hole diameter

(C) Larger sizes as well as intermediate sizes can be furnished



B16.47 Series A Class 400 Weld Neck & Blind

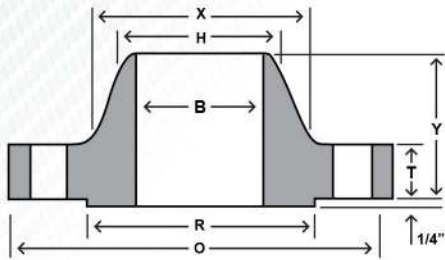

WELD NECK

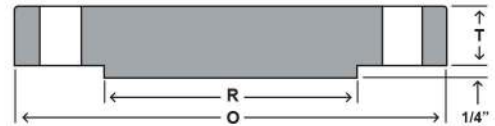

BLIND

Nom Size	Thickness			Drilling									Weight	
	OD	Weld Neck	Blind	OD of RF	Dia at Base	Bore	LTH	Dia Bevel	Bolt Circle	Bolt Length	Hole Dia	# of Holes	Weld Neck	Blind
	O	T	T	R	X	B	Y	H		(A)	(B)			
26	38.25	3.50	3.88	29.50	28.62		7.62	26.00	34.50	12.50	1.88	28	650	1263
28	40.75	3.75	4.12	31.50	30.81		8.12	28.00	37.00	13.25	2.00	28	785	1522
30	43.00	4.00	4.38	33.75	32.94		8.62	30.00	39.25	14.00	2.12	28	905	1802
32	45.25	4.25	4.56	36.00	35.00		9.12	32.00	41.50	14.25	2.12	28	1065	2077
34	47.50	4.38	4.81	38.00	37.19		9.50	34.00	43.50	14.75	2.12	28	1200	2415
36	50.00	4.50	5.06	40.25	39.38		9.88	36.00	46.00	15.00	2.12	32	1340	2815
38	47.50	4.88	4.88	40.75	39.50		8.12	38.00	44.00	14.75	1.88	32	935	2450
40	50.00	5.12	5.12	43.00	41.50		8.50	40.00	46.25	15.50	2.00	32	1090	2848
42	52.00	5.25	5.25	45.00	43.62		8.81	42.00	48.25	15.75	2.00	32	1190	3159
44	54.50	5.50	5.50	47.25	45.62		9.18	44.00	50.50	16.50	2.12	32	1375	3635
46	56.75	5.75	5.75	49.50	47.75		9.62	46.00	52.75	17.00	2.12	36	1525	4120
48	59.50	6.00	6.00	51.50	49.88		10.12	48.00	55.25	18.00	2.38	28	1790	4726
50	61.75	6.19	6.25	53.62	52.00		10.56	50.00	57.50	18.50	2.38	32	1950	5303
52	63.75	6.38	6.44	55.62	54.00		10.88	52.00	59.50	18.75	2.38	32	2125	5823
54	67.00	6.69	6.75	57.88	56.12		11.38	54.00	62.25	20.00	2.62	28	2565	6742
56	69.00	6.88	6.94	60.12	58.25		11.75	56.00	64.25	20.25	2.62	32	2710	7352
58	71.00	7.00	7.12	62.12	60.25		12.06	58.00	66.25	20.50	2.62	32	3230	7986
60	74.25	7.31	7.44	64.38	62.38		12.56	60.00	69.00	21.75	2.88	32	3820	9126

To be specified by Purchasr.

DIMENSIONS ARE IN INCHES | WEIGHTS ARE IN POUNDS

- (A) Bolt lengths are calculated based on bolting one WN to one Blind
- (B) Bolt diameter should be 1/8" less than the bolt hole diameter
- (C) Larger sizes as well as intermediate sizes can be furnished



B16.47 Series A Class 600 Weld Neck & Blind

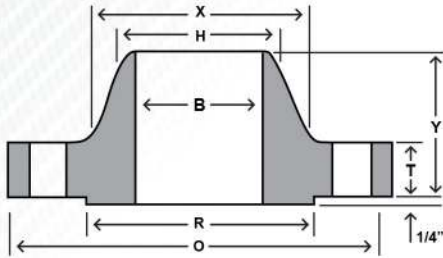

WELD NECK

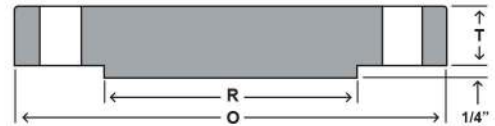

BLIND

Nom Size	Thickness								Drilling				Weights	
	OD	Weld Neck	Blind	OD of RF	Dia at Base	Bore	LTH	Dia Bevel	Bolt Circle	Bolt Length	Hole Dia	# of Holes	Weld Neck	Blind
	O	T	T	R	X	B	Y	H		(A)	(B)			
26	40.00	4.25	4.94	29.50	29.44		8.75	26.00	36.00	14.50	2.00	28	940	1759
28	42.25	4.38	5.19	31.50	31.62		9.25	28.00	38.00	15.00	2.12	28	1060	2061
30	44.50	4.50	5.50	33.75	33.94		9.75	30.00	40.25	15.50	2.12	28	1210	2423
32	47.00	4.62	5.81	36.00	36.12		10.25	32.00	42.50	16.50	2.38	28	1375	2856
34	49.00	4.75	6.06	38.00	38.31		10.62	34.00	44.50	16.75	2.38	28	1540	3237
36	51.75	4.88	6.38	40.25	40.62		11.12	36.00	47.00	17.75	2.62	28	1705	3802
38	50.00	6.00	6.12	41.50	40.25		10.00	38.00	45.75	18.25	2.38	28	1470	3404
40	52.00	6.25	6.38	43.75	42.25		10.38	40.00	47.75	18.75	2.38	32	1630	3838
42	55.25	6.62	6.75	46.00	44.38		11.00	42.00	50.50	19.75	2.62	28	2030	4585
44	57.25	6.81	7.00	48.25	46.50		11.38	44.00	52.50	20.25	2.62	32	2160	5105
46	59.50	7.06	7.31	50.25	48.62		11.81	46.00	54.75	20.75	2.62	32	2410	5758
48	62.75	7.44	7.69	52.50	50.75		12.44	48.00	57.50	22.25	2.88	32	2855	6737
50	65.75	7.75	8.00	54.50	52.88		12.94	50.00	60.00	23.25	3.12	28	3330	7695
52	67.75	8.00	8.25	56.50	54.88		13.25	52.00	62.00	23.75	3.12	32	3560	8426
54	70.00	8.25	8.56	58.75	57.00		13.75	54.00	64.25	24.25	3.12	32	3920	9333
56	73.00	8.56	8.88	60.75	59.12		14.25	56.00	66.75	25.50	3.38	32	4280	10529
58	75.00	8.75	9.12	63.00	61.12		14.56	58.00	68.75	26.00	3.38	32	4640	11414
60	78.50	9.19	9.56	65.25	63.38		15.31	60.00	71.75	27.25	3.62	28	5000	13108

To be specified by Purchaser.

DIMENSIONS ARE IN INCHES | WEIGHTS ARE IN POUNDS

(A) Bolt lengths are calculated based on bolting one WN to one Blind

(B) Bolt diameter should be 1/8" less than the bolt hole diameter

(C) Larger sizes as well as intermediate sizes can be furnished



B16.47 Series A Class 900 Weld Neck & Blind

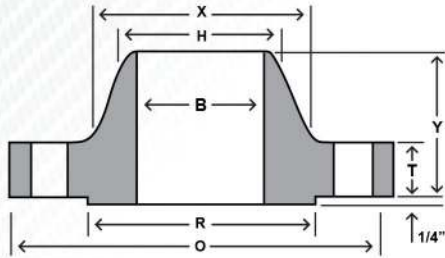

WELD NECK

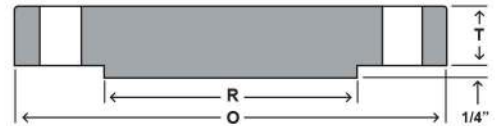

BLIND

Nom Size	Thickness								Drilling				Weight	
	OD	Weld Neck	Blind	OD of RF	Dia at Base	Bore	LTH	Dia Bevel	Bolt Circle	Bolt Length	Hole Dia	# of Holes	Weld Neck	Blind
	O	T	T	R	X	B	Y	H		(A)	(B)			
26	42.75	5.50	6.31	29.50	30.50		11.25	26.00	37.50	18.75	2.88	20	1525	2566
28	46.00	5.62	6.75	31.50	32.75		11.75	28.00	40.25	19.75	3.12	20	1810	3178
30	48.50	5.88	7.18	33.75	35.00		12.25	30.00	42.75	20.50	3.12	20	2120	3758
32	51.75	6.25	7.62	36.00	37.25		13.00	32.00	45.50	22.00	3.38	20	2545	4541
34	55.00	6.50	8.06	38.00	39.62		13.75	34.00	48.25	23.00	3.62	20	2970	5425
36	57.50	6.75	8.44	40.25	41.88		14.25	36.00	50.75	23.75	3.62	20	3395	6209
38	57.50	7.50	8.50	43.25	42.25		13.88	38.00	50.75	24.50	3.62	20	3385	6253
40	59.50	7.75	8.81	45.75	44.38		14.31	40.00	52.75	25.00	3.62	24	3620	6940
42	61.50	8.12	9.12	47.75	46.31		14.62	42.00	54.75	25.75	3.62	24	3960	7675
44	64.88	8.44	9.56	50.00	48.62		15.38	44.00	57.62	27.00	3.88	24	4300	8954
46	68.25	8.88	10.06	52.50	50.88		16.18	46.00	60.50	28.50	4.12	24	4640	10426
48	70.25	9.19	10.38	54.50	52.88		16.50	48.00	62.50	29.00	4.12	24	4980	11398

To be specified by Purchaser.

DIMENSIONS ARE IN INCHES | WEIGHTS ARE IN POUNDS

(A) Bolt lengths are calculated based on bolting one WN to one Blind

(B) Bolt diameter should be 1/8" less than the bolt hole diameter

(C) Larger sizes as well as intermediate sizes can be furnished



B16.47 Series B Class 75 Weld Neck & Blind

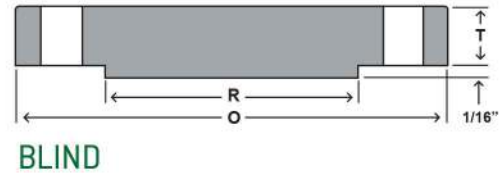
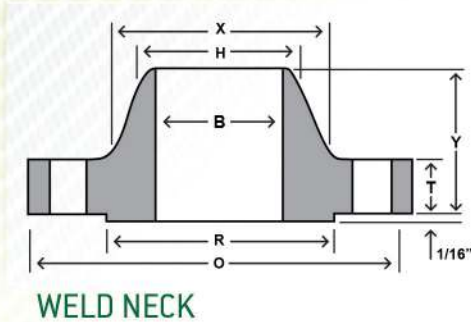

Nom Size	Thickness								Drilling				Weight	
	OD	Weld Neck	Blind	OD of RF	Dia at Base	Bore	LTH	Dia Bevel	Bolt Circle	Bolt Length	Hole Dia	# of Holes	Weld Neck	Blind
	O	T	T	R	X	B	Y	H		(A)	(B)			
26	30.00	1.25	1.25	27.75	26.62		2.25	26.06	28.50	4.50	0.75	36	80	255
28	32.00	1.25	1.25	29.75	28.62		2.38	28.06	30.50	4.50	0.75	40	85	290
30	34.00	1.25	1.25	31.75	30.62		2.50	30.06	32.50	4.50	0.75	44	90	330
32	36.00	1.32	1.38	33.75	32.62		2.69	32.06	34.50	4.75	0.75	48	105	390
34	38.00	1.32	1.44	35.75	34.62		2.82	34.06	36.50	4.75	0.75	52	110	430
36	40.69	1.38	1.61	38.00	36.81		3.32	36.06	39.06	5.25	0.88	40	145	518
38	42.69	1.44	1.69	40.00	38.81		3.44	38.06	41.06	5.50	0.88	40	160	595
40	44.69	1.44	1.69	42.00	40.81		3.57	40.06	43.06	5.50	0.88	44	170	760
42	46.69	1.50	1.82	44.00	42.81		3.69	42.06	45.06	5.50	0.88	48	185	895
44	49.25	1.63	1.88	46.25	44.88		4.07	44.06	47.38	6.00	1.00	36	230	1065
46	51.25	1.69	1.94	48.25	46.88		4.19	46.06	49.38	6.25	1.00	40	245	1185
48	53.25	1.75	2.07	50.25	48.88		4.32	48.06	51.38	6.50	1.00	44	270	1315
50	55.25	1.82	2.13	52.25	50.94		4.50	50.06	53.38	6.50	1.00	44	290	1505
52	57.38	1.82	2.19	54.25	52.94		4.69	52.06	55.50	6.75	1.00	48	310	1665
54	59.38	1.88	2.32	56.25	55.00		4.88	54.06	57.50	6.75	1.00	48	340	1840
56	62.00	1.94	2.38	58.50	57.12		5.25	56.06	59.88	7.25	1.12	40	400	2110
58	64.00	2.00	2.44	60.50	59.12		5.38	58.06	61.88	7.25	1.12	44	430	2300
60	66.00	2.13	2.57	62.50	61.12		5.63	60.06	63.88	7.75	1.12	44	475	2500

To be specified by Purchaser.

DIMENSIONS ARE IN INCHES | WEIGHTS ARE IN POUNDS

(A) Bolt lengths are calculated based on bolting one WN to one Blind

(B) Bolt diameter should be 1/8" less than the bolt hole diameter

(C) Larger sizes as well as intermediate sizes can be furnished



B16.47 Series B Class 150 Weld Neck & Blind

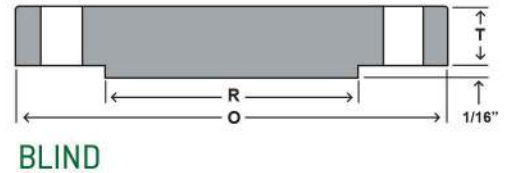
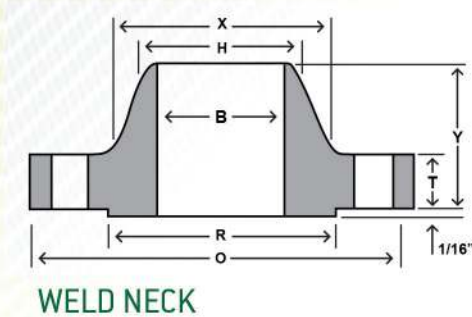

Nom Size	Thickness								Drilling				Weight	
	OD	Weld Neck	Blind	OD of RF	Dia at Base	Bore	LTH	Dia Bevel	Bolt Circle	Bolt Length	Hole Dia	# of Holes	Weld Neck	Blind
	O	T	T	R	X	B	Y	H		(A)	(B)			
26	30.94	1.57	1.69	28.00	26.94		3.44	26.06	29.31	5.50	0.88	36	120	373
28	32.94	1.69	1.82	30.00	28.94		3.69	28.06	31.31	5.75	0.88	40	140	454
30	34.94	1.69	1.94	32.00	31.00		3.88	30.06	33.31	6.00	0.88	44	150	543
32	37.06	1.75	2.07	34.00	33.06		4.19	32.06	35.44	6.25	0.88	48	170	648
34	39.56	1.88	2.19	36.25	35.12		4.28	34.06	37.69	6.75	1.00	40	210	783
36	41.62	2.00	2.25	38.25	37.19		4.57	36.06	39.75	6.75	1.00	44	240	890
38	44.25	2.07	2.44	40.25	39.25		4.82	38.12	42.12	7.50	1.12	40	290	1089
40	46.25	2.13	2.57	42.50	41.31		5.00	40.12	44.12	7.75	1.12	44	310	1247
42	48.25	2.25	2.63	44.50	43.38		5.19	42.12	46.12	7.75	1.12	48	345	1393
44	50.25	2.32	2.75	46.50	45.38		5.32	44.12	48.12	8.00	1.12	52	370	1579
46	52.81	2.38	2.88	48.62	47.44		5.63	46.12	50.56	8.50	1.25	40	435	1824
48	54.81	2.50	3.00	50.75	49.50		5.82	48.12	52.56	8.75	1.25	44	480	2045
50	56.81	2.63	3.13	52.75	51.50		6.00	50.12	54.56	9.00	1.25	48	520	2284
52	58.81	2.69	3.25	54.75	53.56		6.13	52.12	56.56	9.25	1.25	52	550	2547
54	61.00	2.75	3.38	56.75	55.62		6.32	54.12	58.75	9.50	1.25	56	620	2848
56	63.00	2.82	3.50	58.75	57.69		6.50	56.12	60.75	9.75	1.25	60	650	3144
58	65.94	2.88	3.62	60.75	59.69		6.82	58.12	63.44	10.00	1.38	48	780	3560
60	67.94	2.94	3.75	63.00	61.81		7.00	60.12	65.44	10.25	1.38	52	850	3913

To be specified by Purchaser.

DIMENSIONS ARE IN INCHES | WEIGHTS ARE IN POUNDS

- (A) Bolt lengths are calculated based on bolting one WN to one Blind
- (B) Bolt diameter should be 1/8" less than the bolt hole diameter
- (C) Larger sizes as well as intermediate sizes can be furnished



B16.47 Series B Class 300 Weld Neck & Blind

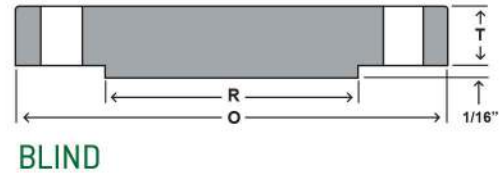
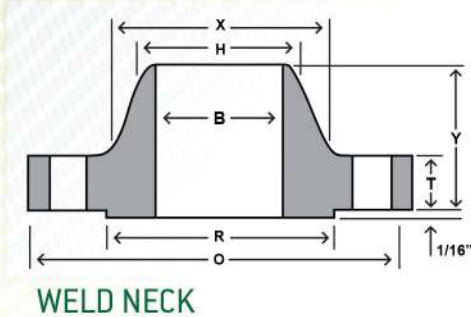

Nom Size	Thickness								Drilling				Weight	
	OD	Weld Neck	Blind	OD of RF	Dia at Base	Bore	LTH	Dia Bevel	Bolt Circle	Bolt Length	Hole Dia	# of Holes	Weld Neck	Blind
	O	T	T	R	X	B	Y	H		(A)	(B)			
26	34.12	3.44	3.44	29.00	27.62		5.63	26.19	31.62	10.50	1.38	32	400	907
28	36.25	3.44	3.44	31.00	29.75		5.81	28.19	33.75	10.50	1.38	36	450	1023
30	39.00	3.63	3.63	33.25	32.00		6.16	30.25	36.25	11.25	1.50	36	550	1249
32	41.50	4.00	4.00	35.50	34.00		6.56	32.25	38.50	12.00	1.62	32	685	1556
34	43.62	4.00	4.00	37.50	36.12		6.75	34.25	40.62	12.00	1.62	36	750	1719
36	46.12	4.00	4.00	39.75	38.00		7.06	36.25	42.88	12.50	1.75	32	840	1921
38	48.12	4.31	4.31	41.75	40.00		7.50	38.25	44.88	13.00	1.75	36	915	2257
40	50.12	4.50	4.50	43.88	42.00		7.75	40.25	46.88	13.50	1.75	40	990	2549
42	52.50	4.63	4.63	46.00	44.00		8.00	42.31	49.00	14.00	1.88	36	1135	2876
44	54.50	4.94	4.94	48.00	46.19		8.38	44.31	51.00	14.50	1.88	40	1235	3304
46	57.50	5.00	5.06	50.00	48.38		8.69	46.31	53.75	15.00	2.00	36	1470	3766
48	59.50	5.00	5.25	52.25	50.31		8.75	48.31	55.75	15.25	2.00	40	1575	4183
50	61.50	5.38	5.44	54.25	52.38		9.19	50.31	57.75	15.75	2.00	44	1710	4629
52	63.50	5.56	5.61	56.25	54.44		9.50	52.31	59.75	16.00	2.00	48	1840	5096
54	65.88	5.32	5.81	58.25	56.50		9.38	54.31	62.12	16.00	2.00	48	1980	5678
56	69.50	6.00	6.12	60.50	58.81		10.50	56.31	65.00	17.75	2.38	36	2595	6642
58	71.94	6.00	6.31	62.75	60.94		10.75	58.31	67.44	18.00	2.38	40	2770	7347
60	73.94	5.88	6.50	65.00	62.94		10.63	60.31	69.44	18.00	2.38	40	2870	7980

To be specified by Purchaser.

DIMENSIONS ARE IN INCHES | WEIGHTS ARE IN POUNDS

(A) Bolt lengths are calculated based on bolting one WN to one Blind

(B) Bolt diameter should be 1/8" less than the bolt hole diameter

(C) Larger sizes as well as intermediate sizes can be furnished



B16.47 Series B Class 400 Weld Neck & Blind

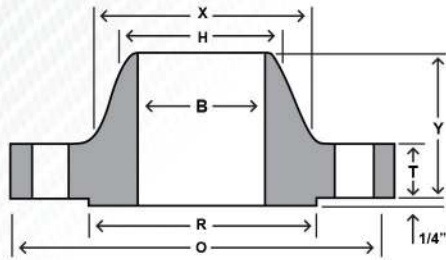

WELD NECK

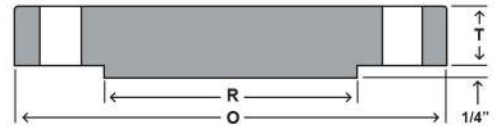

BLIND

Nom Size	Thickness						Drilling					Weight		
	OD	Weld Neck	Blind	OD of RF	Dia at Base	Bore	LTH	Dia Bevel	Bolt Circle	Bolt Length	Hole Dia	# of Holes	Weld Neck	Blind
	O	T	T	R	X	B	Y	H		(A)	(B)			
26	33.50	3.50	3.50	28.00	27.12		5.88	26.00	30.75	11.25	1.50	28	360	874
28	36.00	3.75	3.75	30.00	29.12		6.25	28.00	33.00	12.00	1.62	24	450	1081
30	38.25	4.00	4.00	32.25	31.25		6.69	30.00	35.25	12.50	1.62	28	530	1302
32	40.75	4.25	4.25	34.38	33.25		7.06	32.00	37.50	13.25	1.75	28	635	1570
34	42.75	4.38	4.38	36.50	35.38		7.38	34.00	39.50	13.50	1.75	32	690	1781
36	45.50	4.69	4.69	38.62	37.50		7.88	36.00	42.00	14.50	1.88	28	855	2160
38	47.50	4.88	4.88	40.75	39.50		8.12	38.00	44.00	14.75	1.88	32	935	2450
40	50.00	5.12	5.12	43.00	41.50		8.50	40.00	46.25	15.50	2.00	32	1090	2848
42	52.00	5.25	5.25	45.00	43.62		8.81	42.00	48.25	15.75	2.00	32	1190	3159
44	54.50	5.50	5.50	47.25	45.62		9.18	44.00	50.50	16.50	2.12	32	1375	3635
46	56.75	5.75	5.75	49.50	47.75		9.62	46.00	52.75	17.00	2.12	36	1525	4120
48	59.50	6.00	6.00	51.50	49.88		10.12	48.00	55.25	18.00	2.38	28	1790	4726
50	61.75	6.19	6.25	53.62	52.00		10.56	50.00	57.50	18.50	2.38	32	1950	5303
52	63.75	6.38	6.44	55.62	54.00		10.88	52.00	59.50	18.75	2.38	32	2125	5823
54	67.00	6.69	6.75	57.88	56.12		11.38	54.00	62.25	20.00	2.62	28	2565	6742
56	69.00	6.88	6.94	60.12	58.25		11.75	56.00	64.25	20.25	2.62	32	2710	7352
58	71.00	7.00	7.12	62.12	60.25		12.06	58.00	66.25	20.50	2.62	32	3230	7986
60	74.25	7.31	7.44	64.38	62.38		12.56	60.00	69.00	21.75	2.88	32	3820	9126

To be specified by Purchaser.

DIMENSIONS ARE IN INCHES | WEIGHTS ARE IN POUNDS

(A) Bolt lengths are calculated based on bolting one WN to one Blind

(B) Bolt diameter should be 1/8" less than the bolt hole diameter

(C) Larger sizes as well as intermediate sizes can be furnished



B16.47 Series B Class 600 Weld Neck & Blind

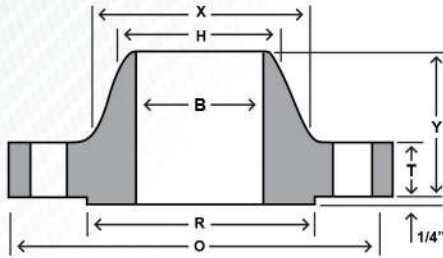

WELD NECK

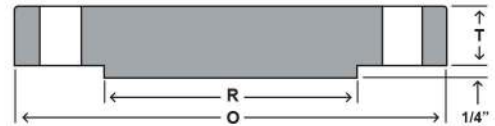

BLIND

Nom Size	Thickness								Drilling				Weights	
	OD	Weld Neck	Blind	OD of RF	Dia at Base	Bore	LTH	Dia Bevel	Bolt Circle	Bolt Length	Hole Dia	# of Holes	Weld Neck	Blind
	O	T	T	R	X	B	Y	H		(A)	(B)			
26	35.00	4.38	4.38	28.62	27.50		7.12	26.00	31.75	13.50	1.75	28	550	1194
28	37.50	4.56	4.56	30.88	29.62		7.50	28.00	34.00	14.25	1.88	28	650	1427
30	40.25	4.94	5.00	33.12	31.75		8.06	30.00	36.50	15.25	2.00	28	810	1802
32	42.75	5.12	5.31	35.25	33.88		8.50	32.00	38.75	16.00	2.12	28	950	2159
34	45.75	5.56	5.68	37.50	36.00		9.19	34.00	41.50	17.25	2.38	24	1205	2645
36	47.75	5.75	5.94	39.75	38.12		9.56	36.00	43.50	17.75	2.38	28	1340	3013
38	50.00	6.00	6.12	41.50	40.25		10.00	38.00	45.75	18.25	2.38	28	1470	3404
40	52.00	6.25	6.38	43.75	42.25		10.38	40.00	47.75	18.75	2.38	32	1630	3838
42	55.25	6.62	6.75	46.00	44.38		11.00	42.00	50.50	19.75	2.62	28	2030	4585
44	57.25	6.81	7.00	48.25	46.50		11.38	44.00	52.50	20.25	2.62	32	2160	5105
46	59.50	7.06	7.31	50.25	48.62		11.81	46.00	54.75	20.75	2.62	32	2410	5758
48	62.75	7.44	7.69	52.50	50.75		12.44	48.00	57.50	22.25	2.88	32	2855	6737
50	65.75	7.75	8.00	54.50	52.88		12.94	50.00	60.00	23.25	3.12	28	3330	7695
52	67.75	8.00	8.25	56.50	54.88		13.25	52.00	62.00	23.75	3.12	32	3560	8426
54	70.00	8.25	8.56	58.75	57.00		13.75	54.00	64.25	24.25	3.12	32	3920	9333
56	73.00	8.56	8.88	60.75	59.12		14.25	56.00	66.75	25.50	3.38	32	4280	10,529
58	75.00	8.75	9.12	63.00	61.12		14.56	58.00	68.75	26.00	3.38	32	4640	11,414
60	78.50	9.19	9.56	65.25	63.38		15.31	60.00	71.75	27.25	3.62	28	5000	13,108

To be specified by Purchaser.

DIMENSIONS ARE IN INCHES | WEIGHTS ARE IN POUNDS

(A) Bolt lengths are calculated based on bolting one WN to one Blind

(B) Bolt diameter should be 1/8" less than the bolt hole diameter

(C) Larger sizes as well as intermediate sizes can be furnished



B16.47 Series B Class 900 Weld Neck & Blind

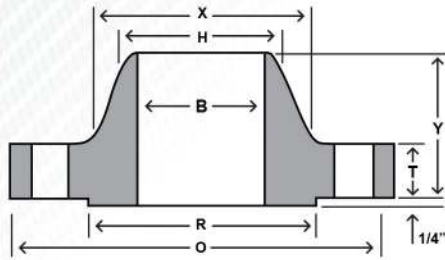

WELD NECK

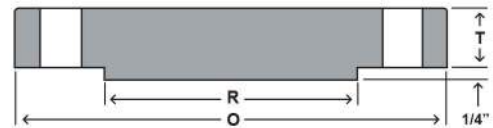

BLIND

Nom Size	Thickness		OD of RF	Dia at Base	Bore	LTH	Dia Bevel	Drilling			Weights			
	OD	Weld Neck						Blind	Bolt Circle	Bolt Length	Hole Dia	# of Holes	Weld Neck	Blind
	O	T						T	R	X	B	Y	H	(A)
26	40.25	5.31	6.06	30.00	29.25	10.19	26.00	35.50	17.75	2.62	20	1050	2184	
28	43.50	5.81	6.56	32.25	31.38	10.88	28.00	38.25	19.50	2.88	20	1520	2762	
30	46.50	6.12	6.93	34.50	33.50	11.38	30.00	40.75	20.50	3.12	20	1820	3334	
32	48.75	6.31	7.31	36.50	35.75	11.94	32.00	43.00	21.00	3.12	20	2065	3865	
34	51.75	6.75	7.68	39.00	37.88	12.56	34.00	45.50	22.50	3.38	20	2450	4576	
36	53.00	6.81	7.94	40.50	40.00	12.81	36.00	47.25	22.25	3.12	24	2520	4963	
38	57.50	7.50	8.50	43.25	42.25	13.88	38.00	50.75	24.50	3.62	20	3385	6253	
40	59.50	7.75	8.81	45.75	44.38	14.31	40.00	52.75	25.00	3.62	24	3620	6940	
42	61.50	8.12	9.12	47.75	46.31	14.62	42.00	54.75	25.75	3.62	24	3960	7675	
44	64.88	8.44	9.56	50.00	48.62	15.38	44.00	57.62	27.00	3.88	24	4300	8954	
46	68.25	8.88	10.06	52.50	50.88	16.18	46.00	60.50	28.50	4.12	24	4640	10,426	
48	70.25	9.19	10.38	54.50	52.88	16.50	48.00	62.50	29.00	4.12	24	4980	11,398	

To be specified by Purchaser.

DIMENSIONS ARE IN INCHES | WEIGHTS ARE IN POUNDS

(A) Bolt lengths are calculated based on bolting one WN to one Blind

(B) Bolt diameter should be 1/8" less than the bolt hole diameter

(C) Larger sizes as well as intermediate sizes can be furnished



B16.47 Series A Class 150# Modified per Industry Standard to be Slip On

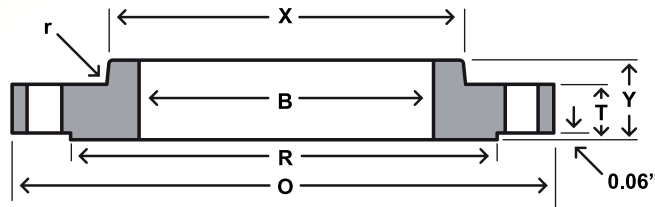

INDUSTRY STANDARD CLASS 150 SERIES "A" SLIP-ON FLANGES (BOLTING MATCHES)

Nom Size								Drilling			Weight
	OD	Thickness	RF Diameter	LTH	Hub Diameter	Min FR	Bore	# of Holes	Hole Dia	Circle Dia	
	O	T	R	Y	X	r	B		(B)		
26	34.25	2.69	29.50	3.69	28.25	0.38	26.25	24	1.38	31.75	235
28	36.5	3.06	31.50	3.81	30.50	0.44	28.25	28	1.38	34	270
30	38.75	3.31	33.75	3.94	32.50	0.44	30.25	28	1.38	36	305
32	41.75	3.41	36.00	4.18	34.50	0.44	32.25	28	1.63	38.5	375
34	43.75	3.68	38.00	4.25	36.50	0.50	34.25	32	1.63	40.5	400
36	46	3.96	40.25	4.56	38.75	0.50	36.25	32	1.63	42.75	450
38	48.75	4.06	42.25	4.56	41.25	0.50	38.25	32	1.63	45.25	530
40	50.75	4.18	44.25	4.81	43.25	0.50	40.25	36	1.63	47.25	570
42	53	4.43	47.00	5.06	45.50	0.50	42.25	36	1.63	49.5	650
44	55.25	4.68	49.00	5.18	47.75	0.50	44.25	40	1.63	51.75	690
46	57.25	4.86	51.00	5.31	49.75	0.50	46.25	40	1.63	53.75	730
48	59.5	5.06	53.50	5.56	52.00	0.50	48.25	44	1.63	56	800

DIMENSIONS ARE IN INCHES

- (A) These flanges will be supplied with a 1/16" raised face unless otherwise specified
- (B) Dimensions are supportive from industry terminology and are a non-committee specification
- (C) These flanges are not covered by ASME B16.47 or MSS-SP44 specifications



B16.47 Series B Class 150# Modified per Industry Standard to be Slip On

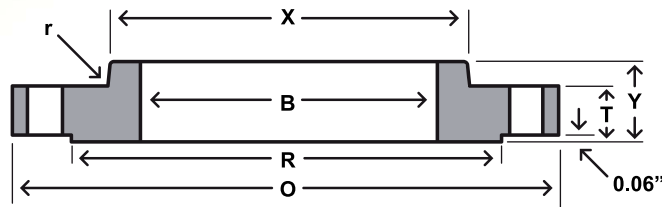

Nom Size								Drilling			Weight
	OD	Thickness	RF Diameter	LTH	Hub Diameter	Min FR	Bore	# of Holes	Hole Dia	Circle Dia	
	O	T	R	Y	X	r	B		(B)		
26	30.94	1.62	28.00	2.62	26.94	0.38	26.25	36	0.88	29.31	85
28	32.94	1.75	30.00	2.75	28.94	0.38	28.25	40	0.88	31.31	97
30	34.94	1.75	32.00	2.75	31.00	0.38	30.25	44	0.88	33.31	103
32	37.06	1.81	34.00	2.81	33.06	0.38	32.25	48	0.88	35.44	125
34	39.56	1.94	36.25	2.94	35.12	0.38	34.25	40	1.00	37.69	165
36	41.62	2.06	38.25	3.06	37.19	0.38	36.25	44	1.00	39.75	186
38	44.25	2.12	40.25	3.12	39.25	0.38	38.25	40	1.12	42.12	227
40	46.25	2.19	42.50	3.19	41.31	0.38	40.25	44	1.12	44.12	245
42	48.25	2.31	44.50	3.31	43.38	0.44	42.25	48	1.12	46.12	269
44	50.25	2.38	46.50	3.38	45.38	0.44	44.25	52	1.12	48.12	288
46	52.81	2.44	48.62	3.44	47.44	0.44	46.25	40	1.25	50.56	343
48	54.81	2.56	50.75	3.56	49.50	0.44	48.25	44	1.25	52.56	373
50	56.81	2.69	52.75	3.69	51.50	0.44	50.25	48	1.25	54.56	403
52	58.81	2.75	54.75	3.75	53.56	0.44	52.25	52	1.25	56.56	426
54	61.00	2.81	56.75	3.81	55.62	0.44	54.25	56	1.25	58.75	469
56	63.00	2.88	58.75	3.88	57.69	0.56	56.25	60	1.25	60.75	492
58	65.94	2.94	60.75	3.94	59.69	0.56	58.25	48	1.38	63.44	602
60	67.94	3.00	63.00	4.00	61.81	0.56	60.25	52	1.38	65.44	634

DIMENSIONS ARE IN INCHES

- (A) These flanges will be supplied with a 1/16" raised face unless otherwise specified
- (B) Dimensions are supportive from industry terminology and are a non-committee specification
- (C) These flanges are not covered by ASME B16.47 or API-605 specifications



B16.47 Series A Class 300# Modified per Industry Standard to be Slip On

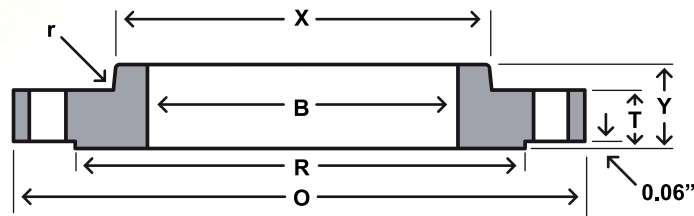

INDUSTRY STANDARD CLASS 300 SERIES "A" SLIP-ON FLANGES (BOLTING MATCHES)

Nom Size								Drilling			Weight
	OD	Thickness	RF Diameter	LTH	Hub Diameter	Bore	Min FR	# of Holes	Hole Dia	Circle Dia	
	O	T	R	Y	X	B	r		{B}		
26	38.25	3.12	29.50	5.37	30.25	0.38	26.25	28	1.75	34.50	595
28	40.75	3.38	31.50	5.68	32.75	0.44	28.25	28	1.75	37.00	729
30	43.00	3.62	33.75	6.12	34.75	0.44	30.25	28	1.88	39.25	840
32	45.25	3.88	36.00	6.56	36.75	0.44	32.25	28	2.00	41.50	964
34	47.50	4.00	38.00	6.81	38.75	0.50	34.25	28	2.00	43.50	1076
36	50.00	4.12	40.25	7.06	41.00	0.50	36.25	32	2.12	46.00	1202
38	46.00	5.31	40.50	6.06	39.00	0.50	38.25	32	1.62	43.00	687
40	48.75	5.56	42.75	6.56	41.25	0.50	40.25	32	1.75	45.50	840
42	50.75	5.81	44.75	6.81	43.25	0.50	42.25	32	1.75	47.50	922
44	53.25	6.06	47.00	6.86	45.25	0.50	44.25	32	1.88	49.75	1055
46	55.75	6.31	49.00	7.06	47.25	0.50	46.25	28	2.00	52.00	1205
48	57.75	6.56	51.25	7.18	49.25	0.50	48.25	32	2.00	54.00	1306

DIMENSIONS ARE IN INCHES

- (A) These flanges will be supplied with a 1/16" raised face unless otherwise specified
- (B) Dimensions are supportive from industry terminology and are a non-committee specification
- (C) These flanges are not covered by ASME B16.47 or MSS-SP44 specifications



Class 125 LW (175–150psi*)

SAME AS AWWA CLASS D HUB

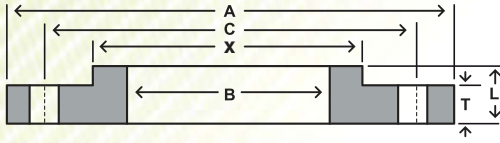

Nom Size						Drilling				Weight
	OD	Thickness	Dia at Base	Bore	LTH	Bolt Circle	Bolt Length	Hole Dia	# of Holes	
	A	T	X	B	L	C				
4	9.00	0.500	5.312	4.57	0.875	7.50	2.75	0.750	8	7
5	10.00	0.562	6.438	5.66	1.250	8.50	3.25	0.875	8	9
6	11.00	0.562	7.562	6.72	1.250	9.50	3.25	0.875	8	11
8	13.50	0.562	9.688	8.72	1.250	11.75	3.25	0.875	8	15
10	16.00	0.688	12.000	10.88	1.250	14.25	3.75	1.000	12	22
12	19.00	0.688	14.375	12.88	1.250	17.00	3.75	1.000	12	33
14	21.00	0.750	15.750	14.19	1.250	18.75	4.00	1.125	12	43
16	23.50	0.750	18.000	16.19	1.250	21.25	4.00	1.125	16	52
18	25.00	0.750	19.875	18.19	1.250	22.75	4.25	1.250	16	52
20	27.50	0.750	22.000	20.19	1.250	25.00	4.25	1.250	20	61
22	29.50	1.000	24.000	22.19	1.750	27.25	5.00	1.375	20	92
24	32.00	1.000	26.125	24.19	1.750	29.50	5.00	1.375	20	105
26	34.25	1.000	28.500	26.19	1.750	31.75	5.00	1.375	24	119
28	36.50	1.000	30.500	28.19	1.750	34.00	5.00	1.375	28	130
30	38.75	1.000	32.500	30.19	1.750	36.00	5.00	1.375	28	144
32	41.75	1.125	34.750	32.19	1.750	38.50	6.00	1.625	28	182
34	43.75	1.125	36.750	34.19	1.750	40.50	6.00	1.625	32	191
36	46.00	1.125	38.750	36.19	1.750	42.75	6.00	1.625	32	207
38	48.75	1.125	40.750	38.19	1.750	45.25	6.00	1.625	32	237
40	50.75	1.125	43.000	40.19	1.750	47.25	6.00	1.625	36	249
42	53.00	1.250	45.000	42.19	1.750	49.50	6.25	1.625	36	287
44	55.25	1.250	47.000	44.19	2.250	51.75	6.25	1.625	40	334
46	57.25	1.250	49.000	46.19	2.250	53.75	6.25	1.625	40	348
48	59.50	1.375	51.000	48.19	2.500	56.00	6.50	1.625	44	407
50	61.75	1.375	53.000	50.19	2.500	58.25	7.00	1.875	44	421
52	64.00	1.375	55.000	52.19	2.500	60.50	7.00	1.875	44	448
54	66.25	1.375	57.000	54.19	2.500	62.75	7.00	1.875	44	475
60	73.00	1.500	63.000	60.19	2.750	69.25	7.25	1.875	52	605
66	80.00	1.500	69.000	66.19	2.750	76.00	7.25	1.875	52	718
72	86.50	1.500	75.000	72.19	2.750	82.50	7.25	1.875	60	803
78	93.00	1.750	81.250	78.19	3.000	89.00	8.25	2.125	64	1010
84	99.75	1.750	87.500	84.19	3.000	95.50	8.25	2.125	64	1160
90	106.50	2.000	93.750	90.19	3.250	102.00	9.50	2.438	68	1430
96	113.25	2.000	100.000	96.19	3.250	108.50	9.50	2.438	68	1618

DIMENSIONS ARE IN INCHES | WEIGHTS ARE IN POUNDS

NOTES: HUB FLANGES ARE TO BE USED ON PIPE THAT HAS AN OD EQUAL TO THE NOMINAL PIPE SIZE IN THE FIRST COLUMN. *PRESSURE RATINGS ARE FROM AWWA TABLE 3 CLASS D. PRESSURE RATING AT ATMOSPHERIC TEMPERATURE: SIZES 4-12" INCLUSIVE, 175 PSI; SIZES LARGER THAN 12", 150 PSI. THESE FLANGES HAVE THE SAME DIAMETER AND DRILLING AS ANSI/ASME B16.1 CLASS 125 CAST IRON FLANGES. IN SIZES 24" AND SMALLER THEY ALSO MATCH UP TO ANSI/ASME B16.5 150-PSI STANDARD FOR STEEL FLANGES.



Class 125 SO (275psi*)

SAME AS AWWA TABLE 4 CLASS E

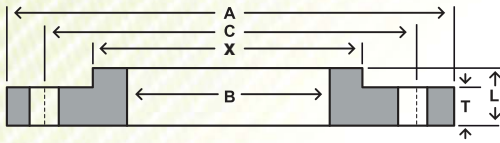

Nom Size						Drilling				Weight
	OD	Thickness	Dia at Base	Bore	LTH	Bolt Circle	Bolt Length	Hole Dia	# of Holes	
	A	T	X	B	L	C				
4	9.00	0.938	5.312	4.57	1.312	7.50	3.75	0.750	8	13
5	10.00	0.938	6.438	5.66	1.438	8.50	4.00	0.875	8	14
6	11.00	1.000	7.562	6.72	1.562	9.50	4.00	0.875	8	17
8	13.50	1.125	9.688	8.72	1.750	11.75	4.50	0.875	8	28
10	16.00	1.188	12.000	10.88	1.938	14.25	5.00	1.000	12	37
12	19.00	1.250	14.375	12.88	2.188	17.00	5.00	1.000	12	59
14	21.00	1.375	15.750	14.19	2.250	18.75	5.50	1.125	12	78
16	23.50	1.438	18.000	16.19	2.500	21.25	5.75	1.125	16	101
18	25.00	1.562	19.875	18.19	2.688	22.75	6.00	1.250	16	110
20	27.50	1.688	22.000	20.19	2.875	25.00	6.50	1.250	20	139
22	29.50	1.812	24.000	22.19	3.125	27.25	6.75	1.375	20	162
24	32.00	1.875	26.125	24.19	3.250	29.50	7.00	1.375	20	197
26	34.25	2.000	28.500	26.19	3.375	31.75	7.25	1.375	24	235
28	36.50	2.062	30.750	28.19	3.438	34.00	7.50	1.375	28	269
30	38.75	2.125	32.750	30.19	3.500	36.00	7.75	1.375	28	303
32	41.75	2.250	35.000	32.19	3.625	38.50	8.50	1.625	28	375
34	43.75	2.312	37.000	34.19	3.688	40.50	8.50	1.625	32	401
36	46.00	2.375	39.250	36.19	3.750	42.75	8.75	1.625	32	452
38	48.75	2.375	41.750	38.19	3.750	45.25	8.75	1.625	32	528
40	50.75	2.500	43.750	40.19	3.875	47.25	9.00	1.625	36	573
42	53.00	2.625	46.000	42.19	4.000	49.50	9.25	1.625	36	648
44	55.25	2.625	48.000	44.19	4.000	51.75	9.25	1.625	40	688
46	57.25	2.688	50.000	46.19	4.062	53.75	9.25	1.625	40	733
48	59.50	2.750	52.250	48.19	4.125	56.00	9.50	1.625	44	799
50	61.75	2.750	54.250	50.19	4.125	58.25	10.00	1.875	44	827
52	64.00	2.875	56.500	52.19	4.250	60.50	10.25	1.875	44	922
54	66.25	3.000	58.750	54.19	4.375	62.75	10.50	1.875	44	1024
60	73.00	3.125	65.250	60.19	4.500	69.25	11.00	1.875	52	1253
66	80.00	3.375	71.500	66.19	4.875	76.00	11.50	1.875	52	1623
72	86.50	3.500	78.500	72.19	5.000	82.50	11.75	1.875	60	1922
78	93.00	3.875	84.500	78.19	5.375	89.00	13.00	2.125	64	2279
84	99.75	3.875	90.500	84.19	5.375	95.50	13.00	2.125	64	2586
90	106.50	4.250	96.750	90.19	5.750	102.00	14.25	2.438	68	3061
96	113.25	4.250	102.750	96.19	5.750	108.50	14.25	2.438	68	3432

DIMENSIONS ARE IN INCHES | WEIGHTS ARE IN POUNDS

NOTES: COMMONLY REFERRED TO AS A CLASS 150# IN LARGER DIAMETER. CAN BE FURNISHED WITH A RAISED FACE. *PRESSURE RATINGS FROM AWWA TABLE 4 CLASS E. PRESSURE RATING AT ATMOSPHERIC TEMPERATURE IS 275 PSI. THESE FLANGES HAVE THE SAME OD AND DRILLING AS ANSI/ASME B16.1 CLASS 125 CAST IRON FLANGES. IN SIZES 24" AND SMALLER, THEY ALSO MATCH ANSI/ASME B16.5 150-PSI STANDARD FOR STEEL FLANGES.



Class 125 WN

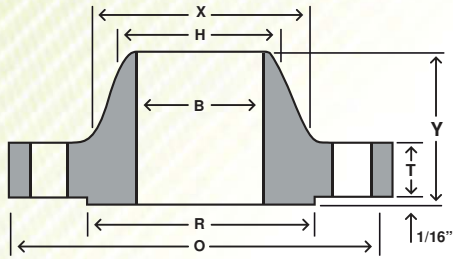

Nom Size								Drilling				Weight
	OD	Thickness	OD of RF	Dia at Base	Bore	Dia Bevel	LTH	Bolt Circle	Bolt Length	Hole Dia	# of Holes	
	O	T	R	X	B	H	Y					
6	11.00	1.00	8.50	7.56		6.63	3.50	9.50	4.00	0.88	8	24
8	13.50	1.13	10.63	9.69		8.63	4.00	11.75	4.50	0.88	8	39
10	16.00	1.19	12.75	12.00		10.75	4.00	14.25	5.00	1.00	12	52
12	19.00	1.25	15.00	14.38		12.75	4.50	17.00	5.00	1.00	12	80
14	21.00	1.38	16.25	15.75		14.00	5.00	18.75	5.50	1.13	12	110
16	23.50	1.44	18.50	18.00		16.00	5.00	21.25	5.75	1.13	16	140
18	25.00	1.56	21.00	19.88		18.00	5.50	22.75	6.00	1.25	16	150
20	27.50	1.69	23.00	22.00		20.00	5.69	25.00	6.50	1.25	20	180
22	29.50	1.81	25.25	24.25		22.00	5.88	27.25	6.75	1.38	20	225
24	32.00	1.88	27.25	26.13		24.00	6.00	29.50	7.00	1.38	20	255
26	34.25	2.00	29.50	28.50		26.00	5.00	31.75	7.25	1.38	24	265
28	36.50	2.06	31.50	30.75		28.00	5.06	34.00	7.50	1.38	28	295
30	38.75	2.13	33.75	32.75		30.00	5.13	36.00	7.75	1.38	28	340
32	41.75	2.25	36.00	35.00		32.00	5.25	38.50	8.50	1.63	28	410
34	43.75	2.31	38.00	37.00		34.00	5.31	40.50	8.50	1.63	32	440
36	46.00	2.38	40.25	39.25		36.00	5.38	42.75	8.75	1.63	32	495
38	48.75	2.38	42.25	41.75		38.00	5.38	45.25	8.75	1.63	32	570
40	50.75	2.50	44.25	43.75		40.00	5.50	47.25	9.00	1.63	36	620
42	53.00	2.63	47.00	46.00		42.00	5.63	49.50	9.25	1.63	36	710
44	55.25	2.63	49.00	48.00		44.00	5.63	51.75	9.25	1.63	40	750
46	57.25	2.69	51.00	50.00		46.00	5.68	53.75	9.25	1.63	40	800
48	59.50	2.75	53.50	52.25		48.00	5.75	56.00	9.50	1.63	44	870
50	61.75	2.75	55.50	54.25		50.00	5.75	58.25	10.00	1.88	44	900
52	64.00	2.88	57.50	56.50		52.00	5.88	60.50	10.25	1.88	44	1000
54	66.25	3.00	59.75	58.75		54.00	6.00	62.75	10.50	1.88	44	1100
60	73.00	3.13	66.00	65.25		60.00	6.13	69.25	11.00	1.88	52	1350
66	80.00	3.38	-	71.50		66.00	6.38	76.00	11.50	1.88	52	1775
72	86.50	3.50	-	78.50		72.00	6.50	82.50	11.75	1.88	60	2100
84	99.75	3.88	-	90.50		84.00	6.88	95.50	13.00	2.13	64	2825
96	113.25	4.25	-	102.75		96.00	7.25	108.50	14.25	2.44	68	3800

To Be Specified by Purchaser.

DIMENSIONS ARE IN INCHES | WEIGHTS ARE IN POUNDS

NOTES: CAN BE FURNISHED WITH A FLAT FACE. THESE FLANGES HAVE THE SAME OD AND DRILLING AS ANSI/ASME B16.1 CLASS 125 CAST IRON FLANGES.



Class 250 (300psi*)

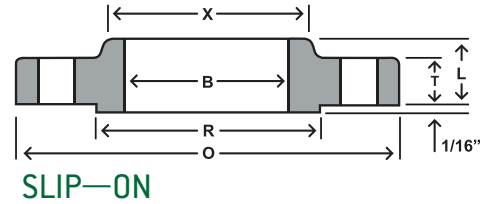
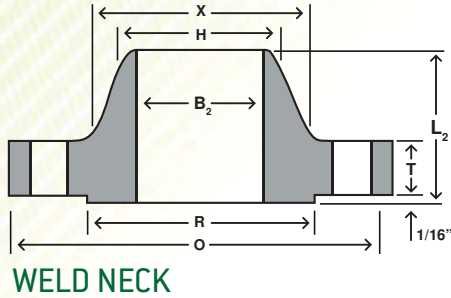

Nom. Size					Bore		LTH		Drilling				Weights		
	OD	Thickness	OD of RF	Dia at Base	WN	SO	Weld Neck	SO	Bolt Circle	Bolt Length	Hole Dia	# Holes	Weld Neck	Slip-on	Blind
	O	T	R	X	B ₂	B	L ₂	L							
26	38.25	2.81	32.44	30.50	To be specified by Purchaser.	26.25	5.81	4.75	34.50	10.00	1.88	28	534	531	916
28	40.75	2.94	34.94	33.00		28.25	5.94	5.00	37.00	10.25	1.88	28	629	637	1095
30	43.00	3.00	37.19	35.25		30.25	6.00	5.00	39.25	10.50	1.88	28	702	707	1236
32	45.25	3.12	39.44	37.50		32.25	6.12	5.12	41.50	10.75	1.88	28	793	801	1424
34	47.50	3.25	41.44	39.50		34.25	6.25	5.25	43.50	11.25	1.88	28	882	889	1649
36	50.00	3.38	43.69	41.50		36.25	6.38	5.38	46.00	12.00	2.13	32	969	970	1884
38	52.25	3.44	45.69	43.50		38.25	6.44	5.50	48.00	12.00	2.13	32	1057	1062	2094
40	54.25	3.56	47.94	45.75		40.25	6.56	5.50	50.25	12.25	2.13	36	1158	1172	2336
42	57.00	3.69	50.44	47.75		42.25	6.94	5.62	52.75	12.50	2.125	36	1318	1288	2673
44	59.25	3.75	52.69	49.75		44.25	7.00	5.75	55.00	12.75	2.13	36	1423	1397	2935
46	61.50	3.88	54.94	51.75	46.25	7.12	5.88	57.25	13.00	2.13	40	1536	1510	3272	
48	65.00	4.00	58.44	54.00	48.25	7.25	6.00	60.75	13.25	2.13	40	1824	1797	3768	

DIMENSIONS ARE IN INCHES | WEIGHTS ARE IN POUNDS

NOTES: *AWWA PRESSURE RATING AT ATMOSPHERIC TEMPERATURE IS 300 PSI. THESE FLANGES HAVE THE SAME OD AND DRILLING AS ANSI/ASME B16.1 CLASS 250 CAST IRON FLANGED



Industry Standard Class 75 Slip—On & Blind

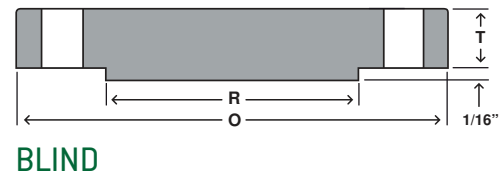
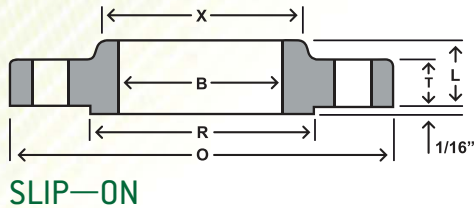

Nom Size	Thickness							Drilling				Weight	
	OD	Slip On	Blind	OD of RF	Dia at Base	Bore ^a	LTH	Bolt Circle	Bolt Length ^b	Hole Dia ^c	# of Holes	Slip On	Blind
	O	T	T	R	X	B	L						
26	33.00	1.25	1.25	30.00	28.50	26.25	2.25	31.00	5.00	1.00	32	120	290
28	35.00	1.25	1.38	32.00	30.50	28.25	2.25	33.00	5.25	1.00	36	140	360
30	37.00	1.25	1.38	34.00	32.50	30.25	2.25	35.00	5.25	1.00	36	150	405
32	39.50	1.25	1.50	36.25	34.63	32.25	2.50	37.38	5.50	1.13	40	170	500
34	41.50	1.25	1.63	38.25	36.63	34.25	2.50	39.38	5.75	1.13	40	180	600
36	43.50	1.25	1.63	40.25	38.63	36.25	2.50	41.38	5.75	1.13	44	190	660
42	50.00	1.25	1.88	46.50	44.75	42.25	2.75	47.75	6.25	1.25	48	235	1000
48	56.00	1.25	2.13	52.50	50.75	48.25	2.88	53.75	6.50	1.25	56	270	1450
54	62.50	1.38	2.38	59.00	57.25	54.25	3.13	60.25	6.75	1.25	68	335	2000
60	68.50	1.63	2.63	65.00	63.25	60.25	3.63	66.25	7.25	1.25	72	450	2675
66	75.50	1.75	2.88	71.63	69.50	66.25	4.00	73.00	8.00	1.38	72	590	3550
72	81.50	2.00	3.13	77.63	75.50	72.25	4.50	79.00	8.50	1.38	80	730	4500

DIMENSIONS ARE IN INCHES | WEIGHTS ARE IN POUNDS

NOTES: LARGER SIZES AS WELL AS INTERMEDIATE SIZES CAN BE FURNISHED. WHEN ORDERING INDUSTRY STANDARD CLASS 75 BLINDS SPECIFY IF THEY ARE TO BE USED WITH WELD NECK OR SLIP—ON FLANGES AS THE BLINDS DIFFER BETWEEN THE TWO.

- (A) Bores listed are most common. They can be specified by the customer where applicable
- (B) Bolt lengths are calculated based on bolting one slip—on to one blind. Any other bolting combination will cause variance in bolt length
- (C) Bolt hole diameter 1/8" larger than bolt diameter



Industry Standard Class 75 Weld Neck & Blind

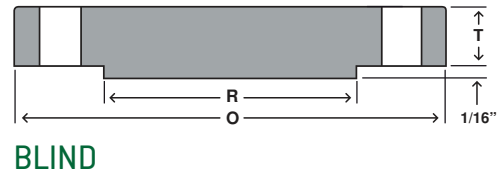
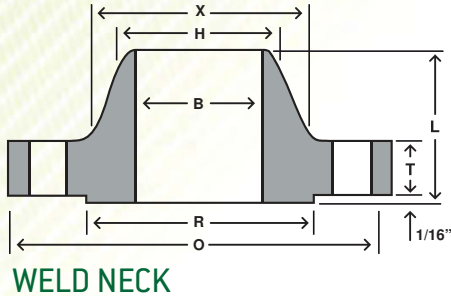

Nom Size	Thickness								Drilling				Weight	
	OD	Weld Neck	Blind	OD of RF	Dia at Base	Bore	LTH	Dia Bevel	Bolt Circle	Bolt Length ^a	Hole Dia ^b	# of Holes	Weld Neck	Blind
	O	T	T	R	X	B	L	H						
26	31.50	1.15	1.25	28.63	27.13		3.00		29.63	5.00	1.00	32	98	265
28	33.50	1.25	1.25	30.63	29.13		3.00		31.63	5.00	1.00	36	105	300
30	35.50	1.25	1.38	32.63	31.13		3.00		33.63	5.25	1.00	36	110	370
32	38.25	1.25	1.50	35.00	33.38		3.25		36.16	5.50	1.13	36	140	470
34	40.25	1.25	1.50	37.00	35.38		3.25		38.13	5.50	1.13	40	150	520
36	42.25	1.25	1.63	39.00	37.38		3.25		40.13	5.75	1.13	40	160	620
42	49.00	1.25	1.88	45.50	43.75		3.50		46.75	6.25	1.25	48	210	970
48	55.00	1.25	2.13	51.50	49.75		3.75		52.75	6.50	1.25	52	240	1375
54	61.25	1.38	2.38	57.75	56.00		4.00		59.00	6.75	1.25	64	310	1925
60	67.25	1.63	2.63	63.75	62.00		4.38		65.00	7.25	1.25	72	400	2575
66	74.00	1.88	2.88	70.13	68.00		4.88		71.50	8.00	1.38	72	560	3400
72	80.00	2.25	3.13	76.13	74.00		5.25		77.50	8.75	1.38	80	700	4350

To be specified by Purchaser.

To be determined by design requirements.

DIMENSIONS ARE IN INCHES | WEIGHTS ARE IN POUNDS

NOTES: LARGER SIZES AS WELL AS INTERMEDIATE SIZES CAN BE FURNISHED. WHEN ORDERING INDUSTRY STANDARD CLASS 75 BLINDS SPECIFY IF THEY ARE TO BE USED WITH WELD NECK OR SLIP—ON FLANGES AS THE BLINDS DIFFER BETWEEN THE TWO.

(A) Bolt lengths are calculated based on bolting one slip—on to one blind. Any other bolting combination will cause variance in bolt length

(B) Bolt hole diameter 1/8" larger than bolt diameter



Industry Standard Class 175

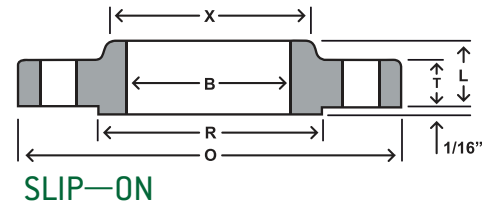
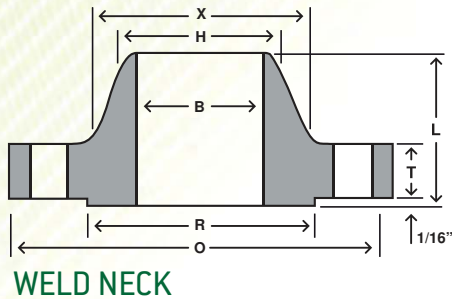

Nom Size	Thickness				OD of RF	Dia at Base	Bore		LTH		Dia Bevel
	OD	Weld Neck	Slip-On	Blind			Weld Neck	Slip-On	Weld Neck	Slip-On	
	O	T	T				B	B	L	L	
26	31.50	1.38	1.38	1.78	29.00	27.63		26.25	3.38	2.75	
28	33.50	1.38	1.38	2.00	31.00	29.63		28.25	3.38	2.75	
30	35.75	1.38	1.38	2.13	33.25	31.88		30.25	3.63	2.75	
32	37.75	1.38	1.38	2.25	35.25	33.88		32.25	3.63	2.75	
34	40.25	1.50	1.75	2.38	37.38	35.88		34.25	3.75	3.38	
36	42.25	1.50	1.75	2.50	39.38	37.88		36.25	3.75	3.38	
38	44.25	1.75	2.00	2.63	41.38	39.88		38.25	4.13	3.75	
40	46.25	1.75	2.00	2.75	43.38	41.88		40.25	4.13	4.00	
42	49.00	2.00	2.38	2.88	45.75	44.13		42.25	4.50	4.38	
44	51.00	2.00	2.38	3.00	47.75	46.13		44.25	4.50	4.38	
46	53.00	2.00	2.38	3.13	49.75	48.13		46.25	4.50	4.63	
48	55.00	2.25	2.63	3.38	51.75	50.13		48.25	4.88	4.88	
50	57.00	2.25	2.63	3.38	53.75	52.13		50.25	4.88	4.88	
52	59.50	2.63	3.00	3.63	56.00	54.25		52.25	5.38	5.38	
54	61.50	2.63	3.00	3.63	58.00	56.25		54.25	5.38	5.38	
60	67.50	2.75	3.13	4.00	64.00	62.25		60.25	5.75	5.88	
66	73.50	3.13	4.00	4.38	70.00	68.50		66.25	6.13	6.88	
72	80.00	3.63	5.00	4.75	76.50	74.50		72.25	6.63	8.00	
84	94.00	3.00	5.00	5.50	90.13	88.00		84.25	7.00	8.50	
96	106.00	3.50	5.00	6.12	102.13	100.00		96.25	7.50	9.00	

To be specified by purchaser.

To be established by design requirements.

DIMENSIONS ARE IN INCHES | WEIGHTS ARE IN POUNDS



Industry Standard Class 175

CONT.

Nom Size	Drilling				Weight		
	Bolt Circle	Bolt Length ^a	Hole Dia ^b	# of Holes	Weld Neck	Slip On	Blind
26	29.88	5.50	0.88	28	120	105	405
28	31.88	5.75	0.88	28	130	115	490
30	34.13	5.75	0.88	36	150	130	590
32	36.13	6.00	0.88	36	160	140	700
34	38.38	6.75	1.00	36	195	200	840
36	40.38	6.75	1.00	36	205	210	970
38	42.38	7.25	1.00	36	245	250	1125
40	44.38	7.25	1.00	40	255	270	1300
42	46.88	8.00	1.13	40	340	365	1500
44	48.88	8.25	1.13	40	360	380	1700
46	50.88	8.25	1.13	40	375	410	1925
48	52.88	8.75	1.13	44	430	460	2225
50	54.88	8.75	1.13	44	450	480	2400
52	57.25	9.75	1.25	44	560	600	2800
54	59.25	9.75	1.25	44	580	620	3000
60	65.25	10.25	1.25	48	680	730	4000
66	71.25	11.50	1.25	56	830	1000	5175
72	77.75	12.75	1.25	64	1075	1400	6650
84	91.5	13.75	1.38	72	1550	2250	-
96	103.5	14.25	1.38	88	1950	2600	-

DIMENSIONS ARE IN INCHES | WEIGHTS ARE IN POUNDS

NOTES: SIZES ARE NOMINAL INSIDE DIAMETERS OF PIPE OR SHELL USED WITH WELDING NECK FLANGES, AND NOMINAL OD OF PIPE OR SHELL USED WITH SLIP—ON FLANGES. LARGER SIZES AS WELL AS INTERMEDIATE SIZES CAN BE FURNISHED.

(A) Bolt lengths are calculated based on bolting one slip—on to one blind. Any other bolting combination will cause variance in bolt length

(B) Bolt hole diameter 1/8" larger than bolt diameter



Industry Standard Class 350

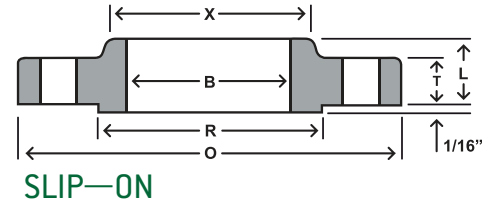
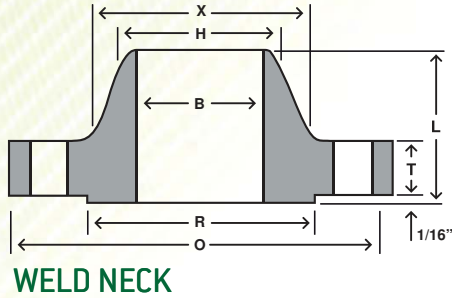

Nom Size	Thickness				OD of RF	Dia at Base	Bore		LTH		Dia Bevel
	OD	Weld Neck	Slip-On	Blind			Weld Neck	Slip-On	Weld Neck	Slip-On	
	O	T	T				B	B	L	L	
26	32.75	2.50	2.50	2.75	29.50	27.88		26.25	5.00	4.50	
28	34.75	2.50	2.50	2.88	31.50	29.88		28.25	5.00	4.50	
30	37.00	2.63	2.63	3.00	33.75	32.13		30.25	5.25	4.75	
32	39.00	2.75	2.75	3.25	35.75	34.13		32.25	5.50	5.00	
34	41.00	2.88	2.88	3.38	37.75	36.13		34.25	5.75	5.13	
36	43.75	3.13	3.13	3.63	40.25	38.50		36.25	6.13	5.63	
38	45.75	3.13	3.13	3.75	42.25	40.50		38.25	6.13	5.63	
40	47.75	3.25	3.25	4.00	44.25	42.50		40.25	6.25	5.88	
42	50.00	3.50	3.50	4.13	46.50	44.75		42.25	6.50	6.13	
44	52.75	3.75	3.75	4.38	48.88	46.75		44.25	6.75	6.75	
46	54.75	4.25	4.25	4.75	50.88	48.75		46.25	7.25	7.25	
48	56.75	4.25	4.25	4.75	52.88	50.75		48.25	7.25	7.25	
52	61.50	4.25	-	-	57.25	55.00		52.25	7.50	-	
54	63.50	4.50	4.75	-	59.25	57.00		54.25	7.75	8.25	
60	69.50	4.50	5.00	-	65.25	63.00		60.25	8.00	8.50	
66	77.00	4.00	-	-	72.38	70.00		66.25	8.50	-	
72	83.00	4.00	-	-	78.38	76.00		72.25	9.00	-	

To be specified by purchaser.

To be established by design requirements.

DIMENSIONS ARE IN INCHES | WEIGHTS ARE IN POUNDS



Industry Standard Class 350

CONT.

Nom Size	Drilling				Weight		
	Bolt Circle	Bolt Length ^a	Hole Dia ^b	# of Holes	Weld Neck	Slip On	Blind
26	30.63	8.00	1.13	28	245	225	580
28	32.63	8.25	1.13	28	260	250	750
30	34.88	8.50	1.13	32	305	295	890
32	36.88	8.75	1.13	36	340	325	1050
34	38.88	9.00	1.13	40	375	355	1225
36	41.50	9.75	1.25	40	480	465	1500
38	43.50	10.00	1.25	40	510	490	1700
40	45.50	10.25	1.25	44	540	530	1975
42	47.75	10.75	1.25	48	640	620	2225
44	50.25	11.50	1.38	44	760	760	2625
46	52.25	12.25	1.38	48	880	880	2950
48	54.25	12.25	1.38	48	920	920	3300
52	58.75	-	1.50	52	1075	-	-
54	60.75	-	1.50	52	1200	1150	-
60	66.75	-	1.50	60	1325	1450	-
66	74.00	-	1.63	60	1675	-	-
72	80.00	-	1.63	72	1850	-	-

DIMENSIONS ARE IN INCHES | WEIGHTS ARE IN POUNDS

NOTES: SIZES ARE NOMINAL INSIDE DIAMETERS OF PIPE OR SHELL USED WITH WELDING NECK FLANGES, AND NOMINAL OD OF PIPE OR SHELL USED WITH SLIP—ON FLANGES. LARGER SIZES AS WELL AS INTERMEDIATE SIZES CAN BE FURNISHED.

(A) Bolt lengths are calculated based on bolting one slip—on to one blind. Any other bolting combination will cause variance in bolt length

(B) Bolt hole diameter 1/8" larger than bolt diameter



Welding Neck Orifice Class 300

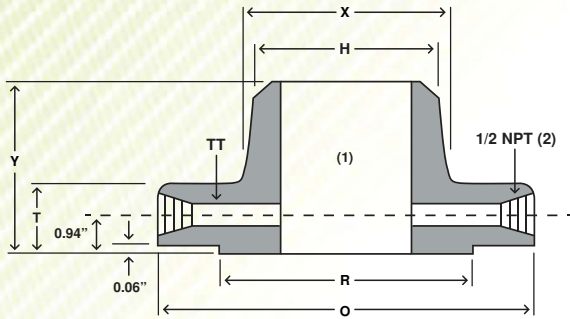

									Drilling			
	Nom Size	OD	Thickness	OD of RF	Dia at Base	Dia Bevel	LTH	Dia of Pressure Connection	Bolt Circle	Hole Dia	# of Holes	Bolt Dia
		O	T	R	X	H	Y	TT				
in	1	4.88	1.50	2.00	2.12	1.32	3.25	1/4	3.50	0.69	4	5/8
mm		124.0	38.1	50.8	53.8	33.5	82.6	6.4	88.9	17.5		15.9
in	1 1/2	6.12	1.50	2.88	2.75	1.90	3.38	1/4	4.50	0.81	4	3/4
mm		155.4	38.1	73.2	69.9	48.3	85.9	6.4	114.3	20.6		19.1
in	2	6.50	1.50	3.62	3.31	2.38	3.38	1/4	5.00	0.69	8	5/8
mm		165.1	38.1	91.9	84.1	60.5	85.9	6.4	127.0	17.5		15.9
in	2 1/2	7.50	1.50	4.12	3.94	2.88	3.50	1/4	5.88	0.81	8	3/4
mm		190.5	38.1	104.6	100.1	73.2	88.9	6.4	149.4	20.6		19.1
in	3	8.25	1.50	5.00	4.62	3.50	3.50	3/8	6.62	0.81	8	3/4
mm		209.6	38.1	127.0	117.3	88.9	88.9	9.5	168.1	20.6		19.1
in	4	10.00	1.50	6.19	5.75	4.50	3.62	1/2	7.88	0.81	8	3/4
mm		254.0	38.1	157.2	146.1	114.3	91.9	12.7	200.2	20.6		19.1
in	6	12.50	1.50	8.50	8.12	6.63	3.94	1/2	10.62	0.88	12	3/4
mm		317.5	38.1	215.9	206.2	168.4	100.1	12.7	269.7	22.4		19.1
in	8	15.00	1.62	10.62	10.25	8.63	4.38	1/2	13.00	1.00	12	7/8
mm		381.0	41.1	269.7	260.4	219.2	111.3	12.7	330.2	25.4		22.2
in	10	17.50	1.88	12.75	12.62	10.75	4.62	1/2	15.25	1.12	16	1
mm		444.5	47.8	323.9	320.5	273.1	117.3	12.7	387.4	28.4		25.4
in	12	20.50	2.00	15.00	14.75	12.75	5.12	1/2	17.75	1.25	16	1 1/8
mm		520.7	50.8	381.0	374.7	323.9	130.0	12.7	450.9	31.8		28.6
in	14	23.00	2.12	16.25	16.75	14.00	5.62	1/2	20.25	1.25	20	1 1/8
mm		584.2	53.8	412.8	425.5	355.6	142.7	12.7	514.4	31.8		28.6
in	16	25.50	2.25	18.50	19.00	16.00	5.75	1/2	22.50	1.38	20	1 1/4
mm		647.7	57.2	469.9	482.6	406.4	146.1	12.7	571.5	35.1		31.8
in	18	28.00	2.38	21.00	21.00	18.00	6.25	1/2	24.75	1.38	24	1 1/4
mm		711.2	60.5	533.4	533.4	457.2	158.8	12.7	628.7	35.1		31.8
in	20	30.50	2.50	23.00	23.12	20.00	6.38	1/2	27.00	1.38	24	1 1/4
mm		774.7	63.5	584.2	587.2	508.0	162.1	12.7	685.8	35.1		31.8
in	24	36.00	2.75	27.25	27.62	24.00	6.62	1/2	32.00	1.62	24	1 1/2
mm		914.4	69.9	692.2	701.5	609.6	168.1	12.7	812.8	41.1		38.1

NOTES: WELD NECK FLANGES NPS 3" AND SMALLER ARE IDENTICAL TO CLASS 600 FLANGES AND MAY BE SO MARKED

(1) Bore diameter to be specified by purchaser

(2) Other NPT and SW connections available upon request

Slip On Orifice Class 300

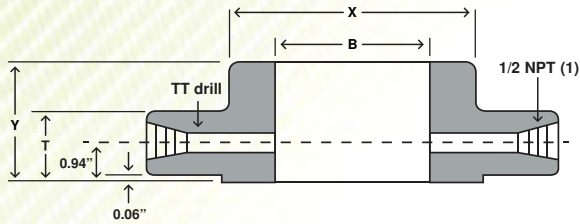

	Nom Size	OD	Thickness	OD of RF	Dia at base	Bore	LTH	Dia of Pressure Connection	Drilling			
									Bolt Circle	Hole Dia	# of holes	Bolt Dia
									O	T	R	X
in	1	4.88	1.50	2.00	2.12	1.36	1.88	1/4	3.50	0.69	4	5/8
mm		124.0	38.1	50.8	53.8	34.5	47.8	6.4	88.9	17.5		15.9
in	1 1/2	6.12	1.50	2.88	2.75	1.95	1.88	1/4	4.50	0.81	4	3/4
mm		155.4	38.1	73.2	69.9	49.5	47.8	6.4	114.3	20.6		19.1
in	2	6.50	1.50	3.62	3.31	2.44	1.94	1/4	5.00	0.69	8	5/8
mm		165.1	38.1	91.9	84.1	62.0	49.3	6.4	127.0	17.5		15.9
in	2 1/2	7.50	1.50	4.12	3.94	2.94	2.00	1/4	5.88	0.81	8	3/4
mm		190.5	38.1	104.6	100.1	74.7	50.8	6.4	149.4	20.6		19.1
in	3	8.25	1.50	5.00	4.62	3.57	2.06	3/8	6.62	0.81	8	3/4
mm		209.6	38.1	127.0	117.3	90.7	52.3	9.5	168.1	20.6		19.1
in	4	10.00	1.50	6.19	5.75	4.57	2.12	1/2	7.88	0.81	8	3/4
mm		254.0	38.1	157.2	146.1	116.1	53.8	12.7	200.2	20.6		19.1
in	6	12.50	1.50	8.50	8.12	6.72	2.12	1/2	10.62	0.88	12	3/4
mm		317.5	38.1	215.9	206.2	170.7	53.8	12.7	269.7	22.4		19.1
in	8	15.00	1.62	10.62	10.25	8.72	2.44	1/2	13.00	1.00	12	7/8
mm		381.0	41.1	269.7	260.4	221.5	62.0	12.7	330.2	25.4		22.2
in	10	17.50	1.88	12.75	12.62	10.88	2.62	1/2	15.25	1.12	16	1
mm		444.5	47.8	323.9	320.5	276.4	66.5	12.7	387.4	28.4		25.4
in	12	20.50	2.00	15.00	14.75	12.88	2.88	1/2	17.75	1.25	16	1 1/8
mm		520.7	50.8	381.0	374.7	327.2	73.2	12.7	450.9	31.8		28.6
in	14	23.00	2.12	16.25	16.75	14.14	3.00	1/2	20.25	1.25	20	1 1/8
mm		584.2	53.8	412.8	425.5	359.2	76.2	12.7	514.4	31.8		28.6
in	16	25.50	2.25	18.50	19.00	16.16	3.25	1/2	22.50	1.38	20	1 1/4
mm		647.7	57.2	469.9	482.6	410.5	82.6	12.7	571.5	35.1		31.8
in	18	28.00	2.38	21.00	21.00	18.18	3.50	1/2	24.75	1.38	24	1 1/4
mm		711.2	60.5	533.4	533.4	461.8	88.9	12.7	628.7	35.1		31.8
in	20	30.50	2.50	23.00	23.12	20.20	3.75	1/2	27.00	1.38	24	1 1/4
mm		774.7	63.5	584.2	587.2	513.1	95.3	12.7	685.8	35.1		31.8
in	24	36.00	2.75	27.25	27.62	24.25	4.19	1/2	32.00	1.62	24	1 1/2
mm		914.4	69.9	692.2	701.5	616.0	106.4	12.7	812.8	41.1		38.1

[1] Other NPT and SW connections available upon request



Threaded Orifice Class 300

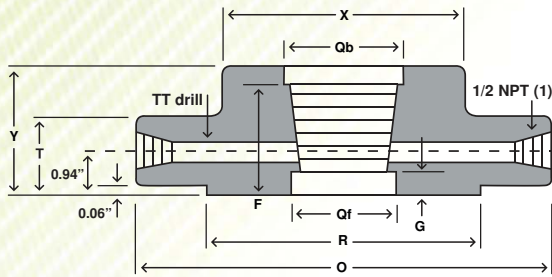

Nom Size	OD	Thickness	OD of RF	Dia at Base	LTH	OD of Counter Bore		Counter Bore Depth [from face]		Dia of Pressure Connection	Drilling				
						Qb ⁽²⁾	Qf ⁽³⁾	F	G		TT	Bolt Circle	Hole Dia	# of Holes	Bolt Dia
						O	T	R	X						
in. 1	4.88	1.50	2.00	2.12	1.88	1.41	1.30	1.44	0.75	1/4	3.50	0.69	4	5/8	
mm.	124.0	38.1	50.8	53.8	47.8	35.8	33.0	36.6	19.1	6.4	88.9	17.5		15.9	
in. 1 1/2	6.12	1.50	2.88	2.75	1.88	1.99	1.89	1.47	0.72	1/4	4.50	0.81	4	3/4	
mm.	155.4	38.1	73.2	69.9	47.8	50.5	48.0	37.3	18.3	6.4	114.3	20.6		19.1	
in. 2	6.50	1.50	3.62	3.31	1.94	2.50	2.36	1.50	0.69	1/4	5.00	0.69	8	5/8	
mm.	165.1	38.1	91.9	84.1	49.3	63.5	59.9	38.1	17.5	6.4	127.0	17.5		15.9	
in. 2 1/2	7.50	1.50	4.12	3.94	2.00	3.00	2.84	1.75	0.56	1/4	5.88	0.81	8	3/4	
mm.	190.5	38.1	104.6	100.1	50.8	76.2	72.1	44.5	14.2	6.4	149.4	20.6		19.1	
in. 3	8.25	1.50	5.00	4.62	2.06	3.63	3.46	1.81	0.56	3/8	6.62	0.81	8	3/4	
mm.	209.6	38.1	127.0	117.3	52.3	92.2	87.9	46.0	14.2	9.5	168.1	20.6		19.1	
in. 4	10.00	1.50	6.19	5.75	2.12	4.63	4.45	1.88	0.56	1/2	7.88	0.81	8	3/4	
mm.	254.0	38.1	157.2	146.1	53.8	117.6	113.0	47.8	14.2	12.7	200.2	20.6		19.1	
in. 6	12.50	1.50	8.50	8.12	2.12	6.75	6.57	1.88	0.31	1/2	10.62	0.88	12	3/4	
mm.	317.5	38.1	215.9	206.2	53.8	171.5	166.9	47.8	7.9	12.7	269.7	22.4		19.1	
in. 8	15.00	1.62	10.62	10.25	2.44	8.75	8.55	2.19	0.44	1/2	13.00	1.00	12	7/8	
mm.	381.0	41.1	269.7	260.4	62.0	222.3	217.2	55.6	11.2	12.7	330.2	25.4		22.2	

[1] Other NPT and SW connections available upon request

[2] Qb counterbore back

[3] Qf counterbore face



Welding Neck Orifice Class 400

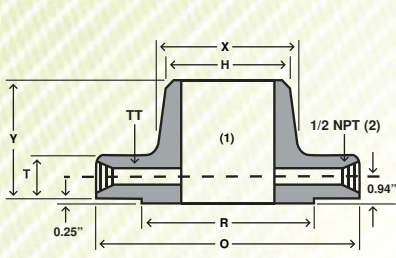

RAISED FACE



SPECIAL 1 OR 2 PIECE RING AND ORIFICE PLATE ASSEMBLY

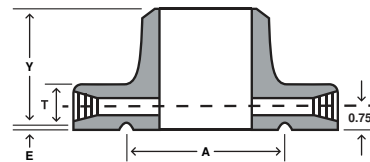

RING TYPE JOINT

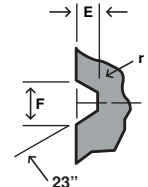

GROOVE DETAIL

	Nom Size	Drilling											Ring Type Joint					
		OD	Thickness	OD of RF	Dia at Base	Dia Bevel	LTH	Dia of Pressure Connection	Bolt Circle	Hole Dia	# of holes	Bolt Dia	Grove #	Pitch Dia	Groove Depth	Groove width	Rad at Bottom	Spec Oval RH
		O	T	R	X	H	Y	TT					P	E	F	r max	W	
in	4	10.00	1.50	6.19	5.75	4.50	3.50	1/2	7.88	1.00	8	7/8	R37	5.875	0.312	0.469	0.03	1.06
mm		254.0	38.1	157.2	146.1	114.3	88.9	12.7	200.2	25.4		22.2		149.225	7.925	11.913	0.8	26.9
in	6	12.50	1.62	8.50	8.12	6.63	4.06	1/2	10.62	1.00	12	7/8	R45	8.312	0.312	0.469	0.03	1.06
mm		317.5	41.1	215.9	206.2	168.4	103.1	12.7	269.7	25.4		22.2		211.125	7.925	11.913	0.8	26.9
in	8	15.00	1.88	10.62	10.25	8.63	4.62	1/2	13.00	1.12	12	1	R49	10.625	0.312	0.469	0.03	1.06
mm		381.0	47.8	269.7	260.4	219.2	117.3	12.7	330.2	28.4		25.4		269.875	7.925	11.913	0.8	26.9
in	10	17.50	2.12	12.75	12.62	10.75	4.88	1/2	15.25	1.25	16	1 1/8	R53	12.750	0.312	0.469	0.03	1.06
mm		444.5	53.8	323.9	320.5	273.1	124.0	12.7	387.4	31.8		28.6		323.850	7.925	11.913	0.8	26.9
in	12	20.50	2.25	15.00	14.75	12.75	5.38	1/2	17.75	1.38	16	1 1/4	R57	15.000	0.312	0.469	0.03	1.06
mm		520.7	57.2	381.0	374.7	323.9	136.7	12.7	450.9	35.1		31.8		381.000	7.925	11.913	0.8	26.9
in	14	23.00	2.39	16.25	16.75	14.00	5.88	1/2	20.25	1.38	20	1 1/4	R61	16.500	0.312	0.469	0.03	1.06
mm		584.2	60.7	412.8	425.5	355.6	149.4	12.7	514.4	35.1		31.8		419.100	7.925	11.913	0.8	26.9
in	16	25.50	2.50	18.50	19.00	16.00	6.00	1/2	22.50	1.50	20	1 3/8	R65	18.500	0.312	0.469	0.03	1.19
mm		647.7	63.5	469.9	482.6	406.4	152.4	12.7	571.5	38.1		34.9		469.900	7.925	11.913	0.8	30.2
in	18	28.00	2.62	21.00	21.00	18.00	6.50	1/2	24.75	1.50	24	1 3/8	R69	21.000	0.312	0.469	0.03	1.19
mm		711.2	66.5	533.4	533.4	457.2	165.1	12.7	628.7	38.1		34.9		533.400	7.925	11.913	0.8	30.2
in	20	30.50	2.75	23.00	23.12	20.00	6.62	1/2	27.00	1.62	24	1 1/2	R73	23.000	0.375	0.531	0.06	1.25
mm		774.7	69.9	584.2	587.12	508.0	168.1	12.7	685.8	41.1		38.1		584.200	9.525	13.487	1.5	31.8
in	24	36.00	3.00	27.25	27.62	24.00	6.88	1/2	32.00	1.89	24	1 3/4						
mm		914.4	76.2	692.2	701.5	609.6	174.8	12.7	812.8	48.0		44.5						

NOTES: WELD NECK FLANGES NPS 3" AND SMALLER ARE IDENTICAL TO CLASS 600 FLANGES AND MAY BE SO MARKED

(1) Bore diameter to be specified by purchaser

(2) Other NPT and SW connections available upon request



Welding Neck Orifice Class 600

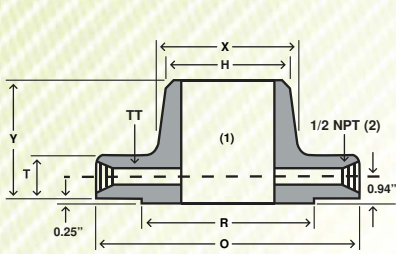

RAISED FACE

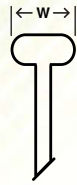

SPECIAL 1 OR 2 PIECE RING AND ORIFICE PLATE ASSEMBLY

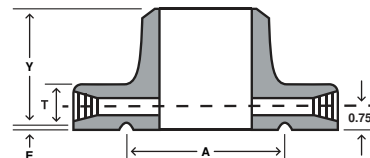

RING TYPE JOINT

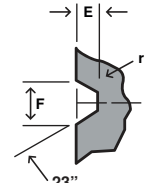

GROOVE DETAIL

in	mm	Nom Size	Drilling											Ring Type Joint					
			OD	Thickness	OD of RF	Dia at base	Dia Bevel	LTH	Dia of Pressure Connection	Bolt Circle	Hole Dia	# of holes	Bolt Dia	Grove #	Pitch Dia	Groove Depth	Groove width	Rad at Bottom	Spec Oval RH
			O	T	R	X	H	Y	TT	RF	RJ			P	E	F	r max	W	
1	4.88	1.50	2.00	2.12	1.32	3.25	1/4	3.50	0.69	0.75	4	5/8	R16	2.000	0.250	0.344	0.03	1.00	
	124.0	38.1	50.8	53.8	33.5	82.6	6.4	88.9	17.50	19.1		15.9		50.800	6.350	8.738	0.8	25.4	
1 1/2	6.12	1.50	2.88	2.75	1.90	3.38	1/4	4.50	0.81	0.88	4	3/4	R20	2.688	0.250	0.344	0.03	1.00	
	155.4	38.1	73.2	69.9	48.3	85.9	6.4	114.3	20.60	22.4		19.1		68.275	6.350	8.738	0.8	25.4	
2	6.50	1.50	3.62	3.31	2.38	3.38	1/4	5.00	0.69	0.75	8	5/8	R23	3.250	0.312	0.469	0.03	1.06	
	165.1	38.1	91.9	84.1	60.5	85.9	6.4	127.00	17.50	19.1		15.9		82.550	7.925	11.913	0.8	26.9	
2 1/2	7.50	1.50	4.12	3.94	2.88	3.50	1/4	5.88	0.81	0.88	8	3/4	R26	4.000	0.312	0.469	0.03	1.06	
	190.5	38.1	104.6	100.1	73.2	88.9	6.4	149.35	20.60	22.4		19.1		101.600	7.925	11.913	0.8	26.9	
3	8.25	1.50	5.00	4.62	3.50	3.50	3/8	6.62	0.81	0.88	8	3/4	R31	4.875	0.312	0.469	0.03	1.06	
	209.6	38.1	127.0	117.3	88.9	88.9	9.5	168.15	20.60	22.4		19.1		123.825	7.925	11.913	0.8	26.9	
4	10.75	1.50	6.19	6.00	4.50	4.00	1/2	8.50	1.00	1.00	8	7/8	R37	5.875	0.312	0.469	0.03	1.06	
	273.1	38.1	157.2	152.4	114.3	101.6	12.7	215.9	25.40	25.4		22.2		149.225	7.925	11.913	0.8	26.9	
6	14.00	1.88	8.50	8.75	6.63	4.62	1/2	11.50	1.12	1.12	12	1	R45	8.312	0.312	0.469	0.03	1.06	
	355.6	47.8	215.9	222.3	168.4	117.3	12.7	292.1	28.40	28.4		25.4		211.125	7.925	11.913	0.8	26.9	
8	16.50	2.19	10.62	10.75	8.63	5.25	1/2	13.75	1.25	1.25	12	1 1/8	R49	10.625	0.312	0.469	0.03	1.06	
	419.1	55.6	269.7	273.1	219.2	133.4	12.7	349.25	31.80	31.8		28.6		269.875	7.925	11.913	0.8	26.9	
10	20.00	2.50	12.75	13.50	10.75	6.00	1/2	17.00	1.38	1.38	16	1 1/4	R53	12.750	0.312	0.469	0.03	1.06	
	508.0	63.5	323.9	342.9	273.1	152.4	12.7	431.8	35.10	35.1		31.8		323.850	7.925	11.913	0.8	26.9	
12	22.00	2.62	15.00	15.75	12.75	6.12	1/2	19.25	1.38	1.38	20	1 1/4	R57	15.000	0.312	0.469	0.03	1.06	
	558.8	66.5	381.0	400.1	323.9	155.4	12.7	488.95	35.10	35.1		31.8		381.000	7.925	11.913	0.8	26.9	
14	23.75	2.75	16.25	17.00	14.00	6.50	1/2	20.75	1.50	1.50	20	1 3/8	R61	16.500	0.312	0.469	0.03	1.06	
	603.3	69.9	412.8	431.8	355.6	165.1	12.7	527.05	38.10	38.1		35.1		419.100	7.925	11.913	0.8	26.9	
16	27.00	3.00	18.50	19.50	16.00	7.00	1/2	23.75	1.60	1.60	20	1 1/2	R65	18.500	0.312	0.469	0.03	1.19	
	685.8	76.2	469.9	495.3	406.4	177.8	12.7	603.25	41.10	41.1		38.1		469.900	7.925	11.913	0.8	30.2	
18	29.25	3.25	21.00	21.50	18.00	7.25	1/2	25.75	1.75	1.75	20	1 5/8	R69	21.000	0.312	0.469	0.03	1.19	
	743.0	82.6	533.4	546.1	457.2	184.2	12.7	654.05	44.50	44.5		41.3		533.400	7.925	11.913	0.8	30.2	
20	32.00	3.50	23.00	24.00	20.00	7.50	1/2	28.50	1.75	1.75	24	1 5/8	R73	23.000	0.375	0.531	0.06	1.25	
	812.8	88.9	584.2	609.6	508.0	190.5	12.7	723.9	44.50	44.5		41.3		584.200	9.525	13.487	1.5	31.8	
24	37.00	4.00	27.25	28.25	24.00	8.00	1/2	33.00	2.00	2.00	24	1 7/8							
	939.8	101.6	692.2	717.6	609.6	203.2	12.7	838.2	50.80	50.8		47.6							

- (1) Bore diameter to be specified by purchaser
- (2) Other NPT and SW connections available upon request



Welding Neck Orifice Class 900

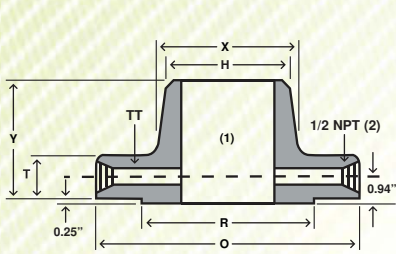

RAISED FACE

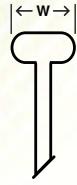

SPECIAL 1 OR 2 PIECE RING AND ORIFICE PLATE ASSEMBLY

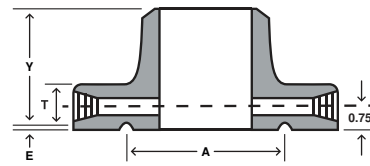

RING TYPE JOINT

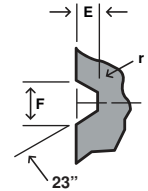

GROOVE DETAIL

	Nom Size	Drilling											Ring Type Joint					
		OD	Thickness	OD of RF	Dia at Base	Dia Bevel	LTH	Dia of Pressure Connection	Bolt Circle	Hole Dia	# of holes	Bolt Dia	Grove #	Pitch Dia	Groove Depth	Groove Width	Rad at Bottom	Spec Oval RH
		O	T	R	X	H	Y	TT					P	E	F	r max	W	
in	3	9.50	1.50	5.00	5.00	3.50	4.00	3/8	7.50	1.00	8	7/8	R31	4.875	0.312	0.469	0.03	1.06
mm		241.3	38.1	127.0	127.0	88.9	101.6	9.5	190.5	25.40		22.2	123.825	7.925	11.913	0.8	26.9	
in	4	11.50	1.75	6.19	6.25	4.50	4.50	1/2	9.25	1.25	8	1 1/8	R37	5.875	0.312	0.469	0.03	1.06
mm		292.1	44.5	157.2	158.8	114.3	114.3	12.7	235.0	31.80		28.6	149.225	7.925	11.913	0.8	26.9	
in	6	15.00	2.19	8.50	9.25	6.63	5.50	1/2	12.50	1.25	12	1 1/8	R45	8.312	0.312	0.469	0.03	1.06
mm		381.0	55.6	215.9	235.0	168.4	139.7	12.7	317.5	31.80		28.6	211.125	7.925	11.913	0.8	26.9	
in	8	18.50	2.50	10.62	11.75	8.63	6.38	1/2	15.50	1.50	12	1 3/8	R49	10.625	0.312	0.469	0.03	1.06
mm		469.9	63.5	269.7	298.5	219.2	162.1	12.7	393.7	38.10		34.9	269.875	7.925	11.913	0.8	26.9	
in	10	21.50	2.75	12.75	14.50	10.75	7.25	1/2	18.50	1.50	16	1 3/8	R53	12.750	0.312	0.469	0.03	1.06
mm		546.1	69.9	323.9	368.3	273.1	184.2	12.7	469.9	38.10		34.9	323.850	7.925	11.913	0.8	26.9	
in	12	24.00	3.12	15.00	16.50	12.75	7.88	1/2	21.00	1.50	20	1 3/8	R57	15.000	0.312	0.469	0.03	1.06
mm		609.6	79.2	381.0	419.1	323.9	200.2	12.7	533.4	38.10		34.9	381.000	7.925	11.913	0.8	26.9	
in	14	25.25	3.38	16.25	17.75	14.00	8.38	1/2	22.00	1.62	20	1 1/2						
mm		641.4	85.9	412.8	450.9	355.6	212.9	12.7	558.8	41.10		38.1						
in	16	27.75	3.50	18.50	20.00	16.00	8.50	1/2	24.30	1.75	20	1 5/8						
mm		704.9	88.9	469.9	508.0	406.4	215.9	12.7	616.0	44.50		41.3						
in	18	31.00	4.00	21.00	22.25	18.00	9.00	1/2	27.00	2.00	20	1 7/8						
mm		787.4	101.6	533.4	565.2	457.2	228.6	12.7	685.8	50.80		47.6						
in	20	33.75	4.25	23.00	24.50	20.00	9.75	1/2	29.50	2.12	20	2						
mm		857.3	108.0	584.2	622.3	508.0	247.7	12.7	749.3	53.80		50.8						
in	24	41.00	5.50	27.25	29.50	24.00	11.50	1/2	35.50	2.62	20	2 1/2						
mm		1041.4	139.7	692.2	749.3	609.6	292.1	12.7	901.7	66.50		63.5						

(1) Bore diameter to be specified by purchaser

(2) Other NPT and SW connections available upon request



Welding Neck Orifice Class 1500

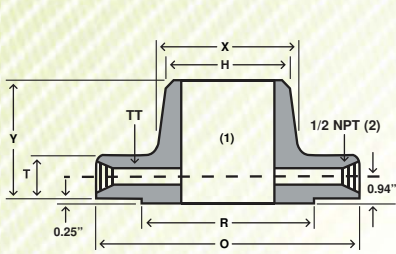

RAISED FACE

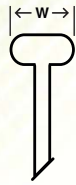

SPECIAL 1 OR 2 PIECE RING AND ORIFICE PLATE ASSEMBLY

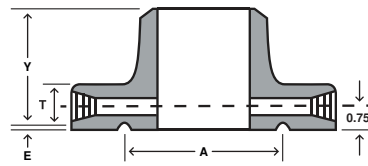

RING TYPE JOINT

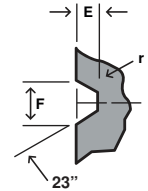

GROOVE DETAIL

	Nom Size								Drilling				Ring Type Joint					
		OD	Thickness	OD of RF	Dia at Base	Dia Bevel	LTH	Dia of Pressure Connection	Bolt Circle	Hole Dia	# of holes	Bolt Dia	Grove #	Pitch Dia	Groove Depth	Groove Width	Rad at Bottom	Spec Oval RH
		O	T	R	X	H	Y	TT					P	E	F	r max	W	
in	1	5.88	1.50	2.00	2.06	1.32	3.25	1/4	4.00	1.00	4	7/8	R16	2.000	0.250	0.344	0.03	1.00
mm		149.4	38.1	50.8	52.3	33.5	82.6	6.4	101.6	25.4	22.2	22.2	50.800	6.350	8.738	0.8	25.4	
in	1 1/2	7.00	1.50	2.88	2.75	1.90	3.50	1/4	4.88	1.12	4	1	R20	2.688	0.250	0.344	0.03	1.00
mm		177.8	38.1	73.2	69.9	48.3	88.9	6.4	124.0	28.4	25.4	25.4	68.275	6.350	8.738	0.8	25.4	
in	2	8.50	1.50	3.62	4.12	2.38	4.00	1/4	6.50	1.00	8	7/8	R24	3.750	0.312	0.469	0.03	1.06
mm		215.9	38.1	91.9	104.6	60.5	101.6	6.4	165.1	25.4	22.2	22.2	95.250	7.925	11.913	0.8	26.9	
in	2 1/2	9.62	1.62	4.12	4.88	2.88	4.12	1/4	7.50	1.12	8	1	R27	4.250	0.312	0.469	0.03	1.06
mm		244.3	41.1	104.6	124.0	73.2	104.6	6.4	190.5	28.4	25.4	25.4	107.950	7.925	11.913	0.8	26.9	
in	3	10.50	1.88	5.00	5.25	3.50	4.62	3/8	8.00	1.25	8	1 1/8	R35	5.375	0.312	0.469	0.03	1.06
mm		266.7	47.8	127.0	133.4	88.9	117.3	9.5	203.2	31.8	28.6	28.6	136.525	7.925	11.913	0.8	26.9	
in	4	12.25	2.12	6.19	6.38	4.50	4.88	1/2	9.50	1.38	8	1 1/4	R39	6.375	0.312	0.469	0.03	1.06
mm		311.2	53.8	157.2	162.1	114.3	124.0	12.7	241.3	35.1	31.8	31.8	161.925	7.925	11.913	0.8	26.9	
in	6	15.50	3.25	8.50	9.00	6.63	6.75	1/2	12.50	1.50	12	1 3/8	R46	8.312	0.375	0.531	0.06	1.12
mm		393.7	82.6	215.9	228.6	168.4	171.5	12.7	317.5	38.1	34.9	34.9	211.125	9.525	13.487	1.5	28.4	
in	8	19.00	3.62	10.62	11.50	8.63	8.38	1/2	15.50	1.75	12	1 5/8
mm		482.6	91.9	269.7	292.1	219.2	212.9	12.7	393.7	44.5	41.3	41.3
in	10	23.00	4.25	12.75	14.50	10.75	10.00	1/2	19.00	2.00	12	1 7/8
mm		584.2	108.0	323.9	368.3	273.1	254.0	12.7	482.6	50.8	47.6	47.6
in	12	26.50	4.88	15.00	17.75	12.75	11.12	1/2	22.50	2.12	16	2
mm		673.1	124.0	381.0	450.9	323.9	282.4	12.7	571.5	53.8	50.8	50.8
in	14	29.50	5.25	16.25	19.50	14.00	11.75	1/2	25.00	2.38	16	2 1/4
mm		749.3	133.4	412.8	495.3	355.6	298.5	12.7	635.0	60.5	57.2	57.2
in	16	32.50	5.75	18.50	21.75	16.00	12.25	1/2	27.80	2.60	16	2 1/2
mm		825.5	146.1	469.9	552.1	406.4	311.2	12.7	704.9	66.5	63.5	63.5
in	18	36.00	6.38	21.00	23.50	18.00	12.88	1/2	30.50	2.88	16	2 3/4
mm		914.4	162.1	533.4	596.9	457.2	327.2	12.7	774.7	73.2	69.9	69.9
in	20	38.75	7.00	23.00	25.25	20.00	14.00	1/2	32.75	3.12	16	3
mm		984.3	177.8	584.2	641.4	508.0	355.6	12.7	831.9	79.2	76.2	76.2
in	24	46.00	8.00	27.25	30.00	24.00	16.00	1/2	39.00	3.62	16	3 1/2
mm		1168.4	203.2	692.2	762.0	609.6	406.4	12.7	990.6	91.9	88.9	88.9

- (1) Bore diameter to be specified by purchaser
- (2) Other NPT and SW connections available upon request



Welding Neck Orifice Class 2500

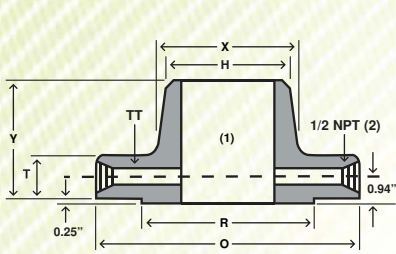

RAISED FACE



SPECIAL 1 OR 2 PIECE RING AND ORIFICE PLATE ASSEMBLY

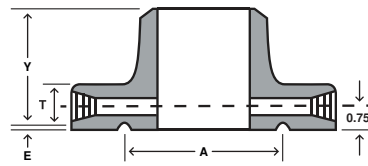

RING TYPE JOINT

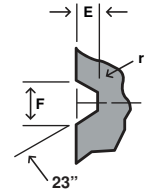

GROOVE DETAIL

	Nom Size								Drilling				Ring Type Joint						
		OD	Thickness	OD of RF	Dia at Base	Dia Bevel	LTH	Dia of Pressure Connection	Bolt Circle	Hole Dia	# of holes	Bolt Dia	Grove #	Pitch Dia	Groove Depth	Groove Width	Rad at Bottom	Spec Oval RH	
		O	T	R	X	H	Y	TT					P	E	F	r max	W		
in	1	6.25	1.50	2.00	2.25	1.32	3.62	1/4	4.25	1.00	4	7/8	R18	2.375	0.250	0.344	0.03	1.00	
mm		158.8	38.1	50.8	57.2	33.5	91.9	6.4	108.0	25.4	22.2	22.2	60.325	6.350	8.738	0.8	25.4		
in	1 1/2	8.00	1.75	2.88	3.12	1.90	4.38	1/4	5.75	1.25	4	1 1/8	R23	3.250	0.312	0.469	0.03	1.06	
mm		203.2	44.5	73.2	79.2	48.3	111.3	6.4	146.1	31.8	28.6	28.6	82.550	7.925	11.913	0.8	26.9		
in	2	9.25	2.00	3.62	3.75	2.38	5.00	1/4	6.75	1.12	8	1	R26	4.000	0.312	0.469	0.03	1.06	
mm		235.0	50.8	91.9	95.3	60.5	127.0	6.4	171.5	28.4	25.4	25.4	101.600	7.925	11.913	0.8	26.9		
in	2 1/2	10.50	2.25	4.12	4.50	2.88	5.62	1/4	7.75	1.25	8	1 1/8	R28	4.375	0.375	0.531	0.06	1.19	
mm		266.7	57.2	104.6	114.3	73.2	142.7	6.4	196.9	31.8	28.6	28.6	111.125	9.525	13.487	1.5	30.2		
in	3	12.00	2.62	5.00	5.25	3.50	6.62	3/8	9.00	1.38	8	1 1/4	R32	5.000	0.375	0.531	0.06	1.19	
mm		304.8	66.5	127.0	133.4	88.9	168.1	9.5	228.6	35.1	31.8	31.8	127.000	9.525	13.487	1.5	30.2		
in	4	14.00	3.00	6.19	6.50	4.50	7.50	1/2	10.75	1.62	8	1 1/2	
mm		355.6	76.2	157.2	165.1	114.3	190.5	12.7	273.1	41.1	38.1	38.1	
in	6	19.00	4.25	8.50	9.25	6.63	10.75	1/2	14.50	2.12	8	2	
mm		482.6	108.0	215.9	235.0	168.4	273.1	12.7	368.3	53.8	50.8	50.8	
in	8	21.75	5.00	10.62	12.00	8.63	12.50	1/2	17.25	2.12	12	2	
mm		552.5	127.0	269.7	304.8	219.2	317.5	12.7	438.2	53.8	50.8	50.8	
in	10	26.50	6.50	12.75	14.75	10.75	16.50	1/2	21.25	2.62	12	2 1/2	
mm		673.1	165.1	323.9	374.7	273.1	419.1	12.7	539.8	66.5	63.5	63.5	
in	12	30.00	7.25	15.00	17.38	12.75	18.25	1/2	24.38	2.88	12	2 3/4	
mm		762.0	184.2	381.0	441.5	323.9	463.6	12.7	619.3	73.2	69.9	69.9	

(1) Bore diameter to be specified by purchaser
 (2) Other NPT and SW connections available upon request



Jack Screw Sizes for Orifice Flanges

RING JOINT FACE															
Nominal Pipe Size	300 Lb.			400 Lb.			600 Lb.			900 Lb.			1500 Lb.		
	Size	Length	Hole Size	Size	Length	Hole Size	Size	Length	Hole Size	Size	Length	Hole Size	Size	Length	Hole Size
1	5/8	3 3/4	11/16	5/8	3 3/4	11/16	5/8	3 3/4	11/16	5/8	3 3/4	3/4	5/8	3 3/4	3/4
1 1/4	5/8	3 3/4	11/16	5/8	3 3/4	11/16	5/8	3 3/4	11/16	5/8	3 3/4	3/4	5/8	3 3/4	3/4
1 1/2	5/8	3 3/4	11/16	5/8	3 3/4	11/16	5/8	3 3/4	11/16	5/8	3 3/4	3/4	5/8	3 3/4	3/4
2	5/8	3 3/4	11/16	5/8	3 3/4	11/16	5/8	3 3/4	11/16	5/8	4	3/4	5/8	4	3/4
2 1/2	3/4	3 3/4	13/16	3/4	3 3/4	13/16	3/4	3 3/4	13/16	5/8	4 1/4	3/4	5/8	4 1/4	3/4
3	3/4	3 3/4	13/16	3/4	3 3/4	13/16	3/4	3 3/4	13/16	3/4	4 1/2	7/8	3/4	4 1/2	7/8
4	3/4	3 3/4	13/16	3/4	4	7/8	3/4	4	7/8	3/4	5	7/8	3/4	5	7/8
5	3/4	4	7/8	3/4	4	7/8	3/4	4 1/2	7/8	3/4	6	7/8	3/4	6	7/8
6	3/4	4	7/8	7/8	4 1/2	1	7/8	4 1/2	1	1	6	1 1/8	1	6	1 1/8
8	3/4	4 1/4	7/8	7/8	4 1/2	1	7/8	5	1	1	7	1 1/8	1	7	1 1/8
10	1	4 1/2	1 1/8	7/8	5	1	7/8	5	1	1	7	1 1/8	1	7	1 1/8
12	1	4 1/2	1 1/8	7/8	5	1	7/8	5 1/2	1	1	8	1 1/8	1	8	1 1/8
14	1	5	1 1/8												
16	1	5	1 1/8												
18	1	5	1 1/8												
20	1	5 1/2	1 1/8												
22	1	5 1/2	1 1/8												
24	1	5 1/2	1 1/8												

RAISED FACE															
Nominal Pipe Size	300 Lb.			400 Lb.			600 Lb.			900 Lb.			1500 Lb.		
	Size	Length	Hole Size	Size	Length	Hole Size	Size	Length	Hole Size	Size	Length	Hole Size	Size	Length	Hole Size
1	5/8	2 3/4	11/16	5/8	2 3/4	11/16	5/8	2 3/4	11/16	5/8	3 1/4	3/4	5/8	3 1/4	3/4
1 1/4	5/8	2 3/4	11/16	5/8	2 3/4	11/16	5/8	2 3/4	11/16	5/8	3 1/4	3/4	5/8	3 1/4	3/4
1 1/2	5/8	2 3/4	11/16	5/8	2 3/4	11/16	5/8	2 3/4	11/16	5/8	3 1/4	3/4	5/8	3 1/4	3/4
2	5/8	2 3/4	11/16	5/8	2 3/4	11/16	5/8	2 3/4	11/16	5/8	3 1/4	3/4	5/8	3 1/4	3/4
2 1/2	5/8	2 3/4	13/16	5/8	2 3/4	13/16	5/8	2 3/4	13/16	5/8	3 1/2	3/4	5/8	3 1/2	3/4
3	3/4	2 3/4	13/16	3/4	2 3/4	13/16	3/4	2 3/4	13/16	3/4	3 3/4	7/8	3/4	3 3/4	7/8
4	3/4	2 3/4	13/16	3/4	3 1/4	7/8	3/4	3 1/4	7/8	3/4	4	7/8	3/4	4	7/8
5	3/4	2 3/4	7/8	3/4	3 1/4	7/8	3/4	3 1/2	7/8	3/4	5	7/8	3/4	5	7/8
6	3/4	2 3/4	7/8	7/8	3 1/2	1	7/8	4	1	1	5	1 1/8	1	5	1 1/8
8	3/4	3	7/8	7/8	4	1	7/8	4	1	1	5 1/2	1 1/8	1	5 1/2	1 1/8
10	1	3 1/2	1 1/8	1 1/8	4	1	7/8	4 1/2	1	1	6	1 1/8	1	6	1 1/8
12	1	3 1/2	1 1/8	1 1/8	4	1	7/8	4 1/2	1	1	7	1 1/8	1	7	1 1/8
14	1	3 1/2	1 1/8												
16	1	3 1/2	1 1/8												
18	1	3 3/4	1 1/8												
20	1	3 3/4	1 1/8												
22	1	4	1 1/8												
24	1	4	1 1/8												



AWWA Standard Steel—Ring Flange (86psi*)

TABLE 2 CLASS B (BLINDS FROM TABLE 7)

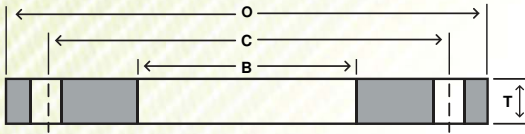

Nom Size	Thickness			Drilling				Weight	
	OD	Slip-On	Blind	Bore	Bolt Circle	Hole Dia	# of Holes	Slip-on	Blind
	O	T	T	B	C				
4	9.00	0.625	0.625	4.57	7.50	0.750	8	8	11
5	10.00	0.625	0.625	5.66	8.50	0.875	8	9	14
6	11.00	0.688	0.688	6.72	9.50	0.875	8	11	19
8	13.50	0.688	0.688	8.72	11.75	0.875	8	15	28
10	16.00	0.688	0.688	10.88	14.25	1.000	12	19	39
12	19.00	0.688	0.719	12.88	17.00	1.000	12	28	58
14	21.00	0.688	0.791	14.19	18.75	1.125	12	34	78
16	23.50	0.688	0.892	16.19	21.25	1.125	16	41	110
18	25.00	0.688	0.950	18.19	22.75	1.250	16	41	132
20	27.50	0.688	1.040	20.19	25.00	1.250	20	49	175
22	29.50	0.750	1.132	22.19	27.25	1.375	20	57	219
24	32.00	0.750	1.216	24.19	29.50	1.375	20	67	277
26	34.25	0.812	1.307	26.19	31.75	1.375	24	80	341
28	36.50	0.875	1.398	28.19	34.00	1.375	28	94	414
30	38.75	0.875	1.477	30.19	36.00	1.375	28	105	493
32	41.75	0.936	1.581	32.19	38.50	1.625	28	132	613
34	43.75	0.938	1.661	34.19	40.50	1.625	32	137	707
36	46.00	1.000	1.751	36.19	42.75	1.625	32	161	824
38	48.75	1.000	1.853	38.19	45.25	1.625	32	185	980
40	50.75	1.000	1.933	40.19	47.25	1.625	36	193	1108
42	53.00	1.125	2.023	42.19	49.50	1.625	36	234	1264
44	55.25	1.125	2.114	44.19	51.75	1.625	40	249	1436
46	57.25	1.125	2.194	46.19	53.75	1.625	40	260	1600
48	59.50	1.250	2.285	48.19	56.00	1.625	44	306	1800
50	61.75	1.250	2.377	50.19	58.25	1.875	44	317	2017
52	64.00	1.250	2.468	52.19	60.50	1.875	44	339	2249
54	66.25	1.375	2.559	54.19	62.75	1.875	44	397	2499
60	73.00	1.500	2.820	60.19	69.25	1.875	52	508	3344
66	80.00	1.625	3.092	66.19	76.00	1.875	52	664	4403
72	86.50	1.750	3.353	72.19	82.50	1.875	60	802	5582
78	93.00	2.000	78.19	89.00	2.125	64	1000
84	99.75	2.000	84.19	95.50	2.125	64	1145
90	106.50	2.250	90.19	102.00	2.438	68	1404
96	113.25	2.250	96.19	108.50	2.438	68	1586
102	120.00	2.500	102.19	114.50	2.688	72	1912
108	126.75	2.500	108.19	120.75	2.688	72	2136
114	133.50	2.750	114.19	126.75	2.938	76	2525
120	140.25	2.750	120.19	132.75	2.938	76	2795
126	147.00	3.000	126.19	139.25	3.188	80	3252
132	153.75	3.000	132.19	145.75	3.188	80	3572
138	160.50	3.250	138.19	152.00	3.438	84	4101
144	167.25	3.250	144.19	158.25	3.438	84	4475

DIMENSIONS ARE IN INCHES | WEIGHTS ARE IN POUNDS

NOTES: *PRESSURE RATING AT ATMOSPHERIC TEMPERATURE IS 86 PSI. THESE FLANGES HAVE THE SAME OD AND DRILLING AS ANSI/ASME B16.1 CLASS 125 CAST IRON FLANGES. IN SIZES 24" AND SMALLER, THEY ALSO MATCH ANSI/ASME B16.5 150-PSI STANDARD FOR STEEL FLANGES.



AWWA Standard Steel—Ring Flange (175–150psi*)

TABLE 2 CLASS D (BLINDS FROM TABLE 7)

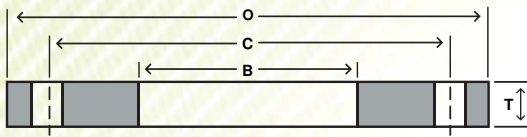

Nom Size	Thickness			Bore	Drilling			Weight	
	OD	Slip-On	Blind		Bolt Circle	Hole Dia	# of Holes	Slip-on	Blind
	O	T	T		B	C			
4	9.00	0.625	0.625	4.57	7.50	0.750	8	8	11
5	10.00	0.625	0.650	5.66	8.50	0.875	8	9	14
6	11.00	0.688	0.693	6.72	9.50	0.875	8	11	19
8	13.50	0.688	0.812	8.72	11.75	0.875	8	15	33
10	16.00	0.688	0.953	10.88	14.25	1.000	12	19	54
12	19.00	0.812	1.117	12.88	17.00	1.000	12	33	90
14	21.00	0.938	1.133	14.19	18.75	1.125	12	47	111
16	23.50	1.000	1.265	16.19	21.25	1.125	16	60	155
18	25.00	1.062	1.331	18.19	22.75	1.250	16	64	185
20	27.50	1.125	1.448	20.19	25.00	1.250	20	79	244
22	29.50	1.188	1.568	22.19	27.25	1.375	20	90	304
24	32.00	1.250	1.661	24.19	29.50	1.375	20	112	378
26	34.25	1.312	1.786	26.19	31.75	1.375	24	129	466
28	36.50	1.312	1.906	28.19	34.00	1.375	28	141	565
30	38.75	1.375	2.008	30.19	36.00	1.375	28	164	671
32	41.75	1.500	2.150	32.19	38.50	1.625	28	211	834
34	43.75	1.500	2.252	34.19	40.50	1.625	32	220	959
36	46.00	1.625	2.370	36.19	42.75	1.625	32	261	1116
38	48.75	1.625	2.506	38.19	45.25	1.625	32	301	1325
40	50.75	1.625	2.609	40.19	47.25	1.625	36	313	1438
42	53.00	1.750	2.729	42.19	49.50	1.625	36	364	1706
44	55.25	1.750	2.849	44.19	51.75	1.625	40	387	1935
46	57.25	1.750	2.952	46.19	53.75	1.625	40	404	2153
48	59.50	1.875	3.072	48.19	56.00	1.625	44	460	2420
50	61.75	2.000	3.196	50.19	58.25	1.875	44	507	2712
52	64.00	2.000	3.315	52.19	60.50	1.875	44	542	3021
54	66.25	2.125	3.435	54.19	62.75	1.875	44	614	3355
60	73.00	2.250	3.779	60.19	69.25	1.875	52	763	4481
66	80.00	2.500	4.136	66.19	76.00	1.875	52	1021	5890
72	86.50	2.625	4.480	72.19	82.50	1.875	60	1203	7458
78	93.00	2.750	78.19	89.00	2.125	64	1374
84	99.75	2.875	84.19	95.50	2.125	64	1646
90	106.50	3.000	90.19	102.00	2.438	68	1872
96	113.25	3.250	96.19	108.50	2.438	68	2291
102	120.00	3.250	102.19	114.50	2.688	72	2485
108	126.75	3.375	108.19	120.75	2.688	72	2884
114	133.50	3.500	114.19	126.75	2.938	76	3214
120	140.25	3.500	120.19	132.75	2.938	76	3558
126	147.00	3.750	126.19	139.25	3.188	80	4065
132	153.75	3.875	132.19	145.75	3.188	80	4614
138	160.50	4.000	138.19	152.00	3.438	84	5047
144	167.25	4.125	144.19	158.25	3.438	84	5680

DIMENSIONS ARE IN INCHES | WEIGHTS ARE IN POUNDS

NOTES: *PRESSURE RATING AT ATMOSPHERIC TEMPERATURE: SIZES 4-12" INCLUSIVE, 175 PSI; SIZES LARGER THAN 12", 150 PSI. THESE FLANGES HAVE THE SAME OD AND DRILLING AS ANSI/ASME B16.1 CLASS 125 CAST-IRON FLANGES. IN SIZES 24" AND SMALLER, THEY ALSO MATCH ANSI/ASME B16.5 150-PSI STANDARD FOR STEEL FLANGES.



AWWA Standard Steel—Hub Flange (175–150psi*)

TABLE 3 CLASS D

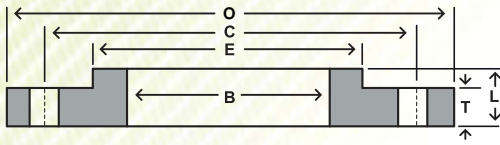

Nom Size	Drilling								
	OD	Thickness	Overall Thickness	Dia at Base	Bore	Bolt Circle	Hole Dia	# of Holes	Weight
	O	T	L	E	B	C			
4	9.00	0.500	0.875	5.312	4.57	7.50	0.750	8	7
5	10.00	0.562	1.250	6.312	5.66	8.50	0.875	8	9
6	11.00	0.562	1.250	7.562	6.72	9.50	0.875	8	11
8	13.50	0.562	1.250	9.688	8.72	11.75	0.875	8	15
10	16.00	0.688	1.250	12.000	10.88	14.25	1.000	12	22
12	19.00	0.688	1.250	14.375	12.88	17.00	1.000	12	33
14	21.00	0.750	1.250	15.750	14.19	18.75	1.125	12	43
16	23.50	0.750	1.250	18.000	16.19	21.25	1.125	16	52
18	25.00	0.750	1.250	19.875	18.19	22.75	1.250	16	52
20	27.50	0.750	1.250	22.000	20.19	25.00	1.250	20	61
22	29.50	1.000	1.750	24.250	22.19	27.25	1.375	20	92
24	32.00	1.000	1.750	26.125	24.19	29.50	1.375	20	105
26	34.25	1.000	1.750	28.500	26.19	31.75	1.375	24	119
28	36.50	1.000	1.750	30.500	28.19	34.00	1.375	28	130
30	38.75	1.000	1.750	32.500	30.19	36.00	1.375	28	144
32	41.75	1.125	1.750	34.750	32.19	38.50	1.625	28	182
34	43.75	1.125	1.750	36.750	34.19	40.50	1.625	32	191
36	46.00	1.125	1.750	38.750	36.19	42.75	1.625	32	207
38	48.75	1.125	1.750	40.750	38.19	45.25	1.625	32	237
40	50.75	1.125	1.750	43.000	40.19	47.25	1.625	36	249
42	53.00	1.250	1.750	45.000	42.19	49.50	1.625	36	287
44	55.25	1.250	2.250	47.000	44.19	51.75	1.625	40	334
46	57.25	1.250	2.250	49.000	46.19	53.75	1.625	40	348
48	59.50	1.375	2.500	51.000	48.19	56.00	1.625	44	407
50	61.75	1.375	2.500	53.000	50.19	58.25	1.875	44	421
52	64.00	1.375	2.500	55.000	52.19	60.50	1.875	44	448
54	66.25	1.375	2.500	57.000	54.19	62.75	1.875	44	475
60	73.00	1.500	2.750	63.000	60.19	69.25	1.875	52	605
66	80.00	1.500	2.750	69.000	66.19	76.00	1.875	52	718
72	86.50	1.500	2.750	75.000	72.19	82.50	1.875	60	803
78	93.00	1.750	3.000	81.250	78.19	89.00	2.125	64	1010
84	99.75	1.750	3.000	87.500	84.19	95.50	2.125	64	1160
90	106.50	2.000	3.250	93.750	90.19	102.00	2.438	68	1430
96	113.25	2.000	3.250	100.000	96.19	108.50	2.438	68	1618

DIMENSIONS ARE IN INCHES | WEIGHTS ARE IN POUNDS

NOTES: HUB FLANGES ARE TO BE USED ON PIPE THAT HAS AN OD EQUAL TO THE NOMINAL PIPE SIZE IN THE FIRST COLUMN.

*PRESSURE RATING AT ATMOSPHERIC TEMPERATURE: SIZES 4-12" INCLUSIVE, 175 PSI; SIZES LARGER THAN 12", 150 PSI. THESE FLANGES HAVE THE SAME OD AND DRILLING AS ANSI/ASME B16.1 CLASS 125 CAST-IRON FLANGES. IN SIZES 24" AND SMALLER, THEY ALSO MATCH ANSI/ASME B16.5 150-PSI STANDARD FOR STEEL FLANGES.



AWWA Standard Steel—Hub Flange (275psi*)

TABLE 4 CLASS E

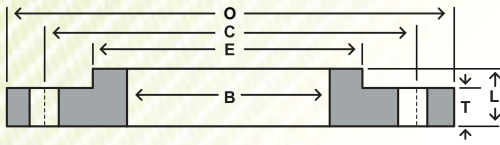

Nom Size	Drilling								
	OD	Thickness	Overall Thickness	Dia at Base	Bore	Bolt Circle	Hole Dia	# of Holes	Weight
	O	T	L	E	B	C			
4	9.00	0.938	1.312	5.312	4.57	7.50	0.750	8	13
5	10.00	0.938	1.438	6.438	5.66	8.50	0.875	8	14
6	11.00	1.000	1.562	7.562	6.72	9.50	0.875	8	17
8	13.50	1.125	1.750	9.688	8.72	11.75	0.875	8	28
10	16.00	1.188	1.938	12.000	10.88	14.25	1.000	12	37
12	19.00	1.250	2.188	14.375	12.88	17.00	1.000	12	59
14	21.00	1.375	2.250	15.750	14.19	18.75	1.125	12	78
16	23.50	1.438	2.500	18.000	16.19	21.25	1.125	16	101
18	25.00	1.562	2.688	19.875	18.19	22.75	1.250	16	110
20	27.50	1.688	2.875	22.000	20.19	25.00	1.250	20	139
22	29.50	1.812	3.125	24.000	22.19	27.25	1.375	20	162
24	32.00	1.875	3.250	26.125	24.19	29.50	1.375	20	197
26	34.25	2.000	3.375	28.500	26.19	31.75	1.375	24	235
28	36.50	2.062	3.438	30.750	28.19	34.00	1.375	28	269
30	38.75	2.125	3.500	32.750	30.19	36.00	1.375	28	303
32	41.75	2.250	3.625	35.000	32.19	38.50	1.625	28	375
34	43.75	2.312	3.688	37.000	34.19	40.50	1.625	32	401
36	46.00	2.375	3.750	39.250	36.19	42.75	1.625	32	452
38	48.75	2.375	3.750	41.750	38.19	45.25	1.625	32	528
40	50.75	2.500	3.875	43.750	40.19	47.25	1.625	36	573
42	53.00	2.625	4.000	46.000	42.19	49.50	1.625	36	648
44	55.25	2.625	4.000	48.000	44.19	51.75	1.625	40	688
46	57.25	2.688	4.062	50.000	46.19	53.75	1.625	40	733
48	59.50	2.750	4.125	52.250	48.19	56.00	1.625	44	799
50	61.75	2.750	4.125	54.250	50.19	58.25	1.875	44	827
52	64.00	2.875	4.250	56.500	52.19	60.50	1.875	44	922
54	66.25	3.000	4.375	58.750	54.19	62.75	1.875	44	1024
60	73.00	3.125	4.500	65.250	60.19	69.25	1.875	52	1253
66	80.00	3.375	4.875	71.500	66.19	76.00	1.875	52	1623
72	86.50	3.500	5.000	78.500	72.19	82.50	1.875	60	1922
78	93.00	3.875	5.375	84.500	78.19	89.00	2.125	64	2279
84	99.75	3.875	5.375	90.500	84.19	95.50	2.125	64	2586
90	106.50	4.250	5.750	96.750	90.19	102.00	2.438	68	3061
96	113.25	4.250	5.750	102.750	96.19	108.50	2.438	68	3432

DIMENSIONS ARE IN INCHES | WEIGHTS ARE IN POUNDS

NOTES: HUB FLANGES ARE TO BE USED ON PIPE THAT HAS AN OD EQUAL TO THE NOMINAL PIPE SIZE IN THE FIRST COLUMN. *PRESSURE RATING AT ATMOSPHERIC TEMPERATURE IS 275 PSI. THESE FLANGES HAVE THE SAME OD AND DRILLING AS ANSI/ASME B16.1 CLASS 125 CAST-IRON FLANGES. IN SIZES 24" AND SMALLER, THEY ALSO MATCH ANSI/ASME B16.5 CLASS 150 STANDARD FOR STEEL FLANGES. THE THICKNESS OF A CLASS 150 FLANGE FROM WHICH THE RAISED FACE HAS BEEN REMOVED SHALL BE NO LESS THAN DIMENSION T MINUS 0.06"



AWWA Standard Steel—Ring Flange (275psi*)

TABLE 5 CLASS E (BLINDS FROM TABLE 7)

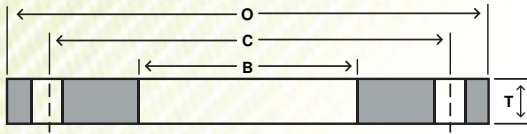

Nom Size	Thickness			Bore	Drilling			Weight	
	OD	Slip-On	Blind		Bolt Circle	Hole Dia	# of Holes	Slip-on	Blind
	O	T	T		B	C			
4	9.00	1.125	1.125	4.57	7.50	0.750	8	14	20
5	10.00	1.188	1.188	5.66	8.50	0.875	8	16	26
6	11.00	1.313	1.313	6.72	9.50	0.875	8	20	35
8	13.50	1.500	1.500	8.72	11.75	0.875	8	33	61
10	16.00	1.563	1.563	10.88	14.25	1.000	12	44	89
12	19.00	1.750	1.750	12.88	17.00	1.000	12	71	141
14	21.00	1.875	1.875	14.19	18.75	1.125	12	94	184
16	23.50	2.000	2.000	16.19	21.25	1.125	16	120	246
18	25.00	2.125	2.125	18.19	22.75	1.250	16	127	296
20	27.50	2.375	2.375	20.19	25.00	1.250	20	168	400
22	29.50	2.500	2.500	22.19	27.25	1.375	20	189	484
24	32.00	2.625	2.625	24.19	29.50	1.375	20	234	598
26	34.25	2.750	2.750	26.19	31.75	1.375	24	270	718
28	36.50	2.750	2.750	28.19	34.00	1.375	28	297	815
30	38.75	2.875	2.875	30.19	36.00	1.375	28	344	961
32	41.75	3.000	3.000	32.19	38.50	1.625	28	422	1163
34	43.75	3.000	3.050	34.19	40.50	1.625	32	441	1299
36	46.00	3.125	3.209	36.19	42.75	1.625	32	502	1511
38	48.75	3.125	3.394	38.19	45.25	1.625	32	580	1795
40	50.75	3.250	3.533	40.19	47.25	1.625	36	626	2025
42	53.00	3.375	3.695	42.19	49.50	1.625	36	701	2309
44	55.25	3.375	3.857	44.19	51.75	1.625	40	747	2715
46	57.25	3.438	3.997	46.19	53.75	1.625	40	794	2813
48	59.50	3.500	4.159	48.19	56.00	1.625	44	858	3276
50	61.75	3.500	4.327	50.19	58.25	1.875	44	887	3671
52	64.00	3.625	4.489	52.19	60.50	1.875	44	982	4091
54	66.25	3.750	4.651	54.19	62.75	1.875	44	1083	4542
60	73.00	3.875	5.116	60.19	69.25	1.875	52	1313	6066
66	80.00	4.250	5.601	66.19	76.00	1.875	52	1736	7976
72	86.50	4.375	6.066	72.19	82.50	1.875	60	2005	10099
78	93.00	4.750	78.19	89.00	2.125	64	2374
84	99.75	4.750	84.19	95.50	2.125	64	2719
90	106.50	5.125	90.19	102.00	2.438	68	3197
96	113.25	5.125	96.19	108.50	2.438	68	3613
102	120.00	5.500	102.19	114.50	2.688	72	4206
108	126.75	5.500	108.19	120.75	2.688	72	4700
114	133.50	5.875	114.19	126.75	2.938	76	5395
120	140.25	5.875	120.19	132.75	2.938	76	5972
126	147.00	6.250	126.19	139.25	3.188	80	6775
132	153.75	6.250	132.19	145.75	3.188	80	7442
138	160.50	6.750	138.19	152.00	3.438	84	8517
144	167.25	6.750	144.19	158.25	3.438	84	9295

DIMENSIONS ARE IN INCHES | WEIGHTS ARE IN POUNDS

NOTES: *PRESSURE RATING AT ATMOSPHERIC TEMPERATURE IS 275 PSI. THESE FLANGES HAVE THE SAME OD AND DRILLING AS ANSI/ASME B16.1 CLASS 125 CAST-IRON FLANGES. IN SIZES 24" AND SMALLER, THEY ALSO MATCH ANSI/ASME B16.5 150-PSI STANDARD FOR STEEL FLANGES.



AWWA Standard Steel—Ring Flange (300psi*)

TABLE 6 CLASS F (BLINDS FROM TABLE 7)

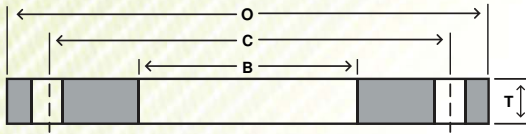

Nom Size	Thickness			Bore	Drilling			Weight	
	OD	Slip-On	Blind		Bolt Circle	Hole Dia	# of Holes	Slip-on	Blind
	O	T	T		C				
4	10.00	1.130	1.130	4.57	7.88	0.875	8	18	25
5	11.00	1.210	1.210	5.66	9.25	0.875	8	22	33
6	12.50	1.310	1.310	6.73	10.62	0.875	12	30	46
8	15.00	1.310	1.310	8.73	13.00	1.000	12	40	66
10	17.50	1.500	1.500	10.88	15.25	1.125	16	56	102
12	20.50	1.630	1.630	12.88	17.75	1.250	16	83	152
14	23.00	1.940	1.940	14.19	20.25	1.250	20	128	228
16	25.50	2.140	2.140	16.19	22.50	1.375	20	167	310
18	28.00	2.250	2.250	18.19	24.75	1.375	24	204	392
20	30.50	2.330	2.330	20.19	27.00	1.375	24	247	482
22	33.00	2.500	2.500	22.19	29.25	1.375	24	307	606
24	36.00	2.690	2.690	24.19	32.00	1.625	24	388	776
26	38.25	3.000	3.000	26.19	34.50	1.875	28	451	977
28	40.75	3.130	3.130	28.19	37.00	1.875	28	532	1156
30	43.00	3.150	3.166	30.19	39.25	1.875	28	586	1303
32	45.25	3.250	3.332	32.19	41.50	1.875	28	657	1518
34	47.50	3.380	3.475	34.19	43.50	1.875	28	741	1745
36	50.00	3.460	3.671	36.19	46.00	2.125	32	802	2042
38	52.25	3.500	3.815	38.19	48.00	2.125	32	874	2317
40	54.25	3.630	3.982	40.19	50.25	2.125	36	937	2608
42	57.00	3.810	4.171	42.19	52.75	2.125	36	1103	3015
44	59.25	4.000	4.338	44.19	55.00	2.125	36	1237	3388
46	61.50	4.130	4.505	46.19	57.25	2.125	40	1344	3791
48	65.00	4.500	4.781	48.19	60.75	2.125	40	1718	4494

DIMENSIONS ARE IN INCHES | WEIGHTS ARE IN POUNDS

NOTES: *PRESSURE RATING AT ATMOSPHERIC TEMPERATURE IS 300 PSI. THESE FLANGES HAVE THE SAME OD AND DRILLING AS ANSI/ASME B16.1 CLASS 250 CAST-IRON PIPE AND FLANGED FITTINGS.



Class 150 Standard Connection Specifications

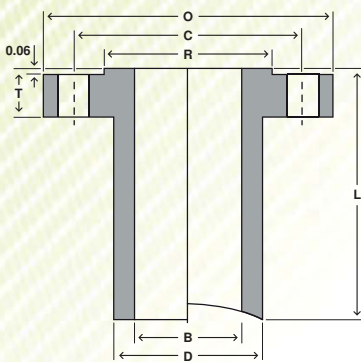

LONG WELD NECK "LWN"

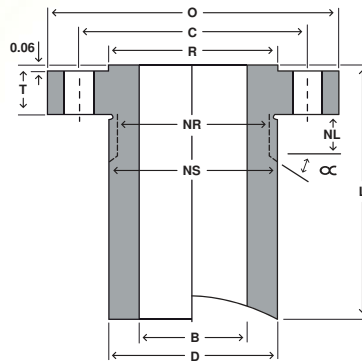

HEAVY BARREL "HB"

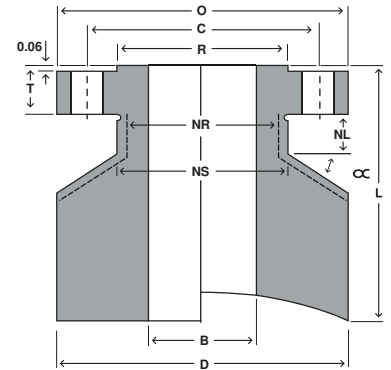

EQUAL BARREL "E"

Size		Flange				Barrel OD			Bolting			Nut			Stud Bolt			Weights						Length
Norm	Bore LWN & E	Bore HB	OD	Thk.	RF of OD	LWN	HB	E	# of Holes	Hole Size	Bolt Circle	Stop Dia	Relief Dia	Relief Length	Size	RF Length	RTJ Length	LWN		HB		E		Base
	B	B	O	T	R	D	D	D			C	NS	NR	NL				Base	Per 1"	Base	Per 1"	Base	Per 1"	L
1/2	0.50	0.55	3.50	0.44	1.38	1.25	1.50	3.50	4	0.62	2.38	1.50	1.25	0.75	1/2	2 1/4	2 3/4	3	0.3	5	0.4	21	2.7	9
3/4	0.75	0.74	3.88	0.50	1.69	1.62	1.88	3.88	4	0.62	2.75	1.88	1.62	0.75	1/2	2 1/2	3	5	0.5	7	0.7	27	3.2	9
1	1.00	0.96	4.25	0.56	2.00	2.00	2.25	4.25	4	0.62	3.12	2.25	2.00	0.75	1/2	2 1/2	3	7	0.7	10	0.9	30	3.8	9
1 1/4	1.25	1.28	4.62	0.62	2.50	2.38	2.62	4.62	4	0.62	3.50	2.62	2.38	0.75	1/2	2 3/4	3 1/4	10	0.9	12	1.2	36	4.4	9
1 1/2	1.50	1.50	5.00	0.69	2.88	2.62	3.00	5.00	4	0.62	3.88	3.00	2.62	0.75	1/2	2 3/4	3 1/4	12	1	16	1.5	41	5.1	9
2	2.00	1.94	6.00	0.75	3.62	3.06	3.69	6.00	4	0.75	4.75	3.69	3.06	0.88	5/8	3 1/4	3 3/4	15	1.2	23	2.2	57	7.1	9
2 1/2	2.50	2.32	7.00	0.88	4.12	3.75	4.44	7.00	4	0.75	5.50	4.44	3.75	0.88	5/8	3 1/2	4	22	1.7	34	3.2	79	10	9
3	3.00	2.90	7.50	0.94	5.00	4.25	4.94	7.50	4	0.75	6.00	4.94	4.25	0.88	5/8	3 1/2	4 1/4	25	2	38	3.6	86	11	9
3 1/2	3.50	3.36	8.50	0.94	5.50	4.88	5.94	8.50	8	0.75	7.00	5.94	4.88	0.88	5/8	3 1/2	4 1/4	32	2.6	55	5.3	110	13	9
4	4.00	3.83	9.00	0.94	6.19	5.50	6.44	9.00	8	0.75	7.50	6.44	5.50	0.88	5/8	3 1/2	4 1/4	47	3.2	78	6	164	14	12
5	5.00	4.81	10.00	0.94	7.31	6.50	7.25	10.00	8	0.88	8.50	7.25	6.50	1.00	3/4	3 3/4	4 1/2	57	3.8	87	6.5	189	17	12
6	6.00	5.76	11.00	1.00	8.50	7.75	8.25	11.00	8	0.88	9.50	8.25	7.75	1.00	3/4	4	4 1/2	75	5.4	103	7.8	216	19	12
8	8.00	7.62	13.50	1.12	10.62	9.75	10.50	13.50	8	0.88	11.75	10.50	9.75	1.00	3/4	4 1/4	4 3/4	102	6.9	157	11	292	26	12
10	10.00	9.56	16.00	1.19	12.75	12.00	12.81	16.00	12	1.00	14.25	12.81	12.00	1.12	7/8	4 3/4	5 1/4	143	9.8	214	16	382	35	12
12	12.00	11.38	19.00	1.25	15.00	14.38	15.56	19.00	12	1.00	17.00	15.56	14.38	1.12	7/8	4 3/4	5 1/2	205	14	329	25	535	48	12
14	14.00	14.00	21.00	1.38	16.25	16.00	17.12	21.00	12	1.12	18.75	17.12	16.00	1.25	1	5 1/4	6	211	13	296	22	585	55	12
16	16.00	16.00	23.50	1.44	18.50	18.00	19.62	23.50	16	1.12	21.25	19.62	18.00	1.25	1	5 1/2	6	246	15	388	29	714	66	12
18	18.00	18.00	25.00	1.56	21.00	20.00	20.94	25.00	16	1.25	22.75	20.94	20.00	1.38	1 1/8	6	6 1/2	270	17	362	25	711	67	12
20	20.00	20.00	27.50	1.69	23.00	22.00	23.19	27.50	20	1.25	25.00	23.19	22.00	1.38	1 1/8	6 1/4	7	311	19	434	31	840	79	12
24	24.00	24.00	32.00	1.88	27.25	26.25	27.50	32.00	20	1.38	29.50	27.50	26.25	1.50	1 1/4	7	7 3/4	423	25	574	40	1046	100	12

For intermediate connections, see subcategory under Flange Dims/Weights at www.texasflange.com.

DIMENSIONS ARE IN INCHES | WEIGHTS ARE IN POUNDS



Class 300 Standard Connection Specifications

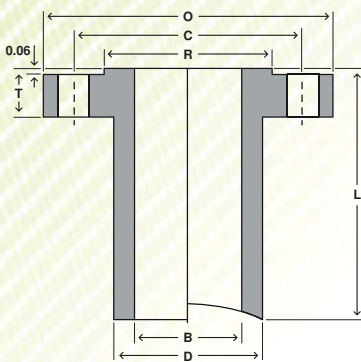

LONG WELD NECK "LWN"

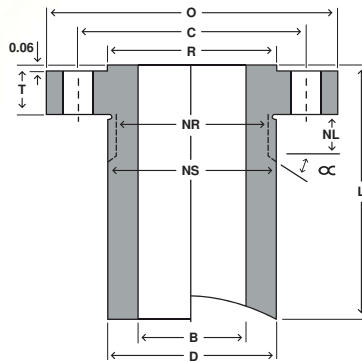

HEAVY BARREL "HB"

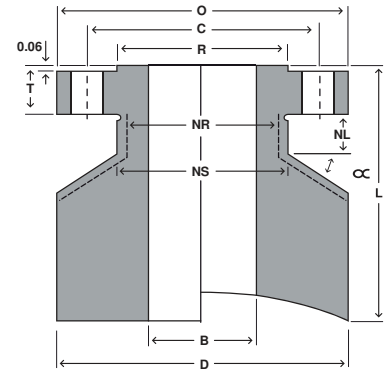

EQUAL BARREL "E"

Size		Flange			Barrel OD			Bolting			Nut			Stud Bolt			Weights						Length	
Nom	Bore LWN & E	Bore HB	OD	Thk	RF of OD	LWN	HB	E	# of Holes	Hole Size	Bolt Circle	Stop Dia	Relief Dia	Relief Length	Size	RF Length	RTJ Length	LWN		HB		E		Base
	B	B	O	T	R	D	D	D			C	NS	NR	NL				Base	Per 1"	Base	Per 1"	Base	Per 1"	L
1/2	0.50	0.55	3.75	0.56	1.38	1.50	1.75	3.75	4	0.62	2.62	1.75	1.50	0.75	1/2	2 1/2	3	5	0.4	7	0.6	24	3.1	9
3/4	0.75	0.74	4.62	0.62	1.69	1.88	2.19	4.62	4	0.75	3.25	2.19	1.88	0.88	5/8	3	3 1/2	9	0.7	11	0.9	37	4.6	9
1	1.00	0.96	4.88	0.69	2.00	2.12	2.44	4.88	4	0.75	3.50	2.44	2.12	0.88	5/8	3 1/4	3 1/2	9	0.8	12	1.1	40	5.1	9
1 1/4	1.25	1.28	5.25	0.75	2.50	2.50	2.81	5.25	4	0.75	3.88	2.81	2.50	0.88	5/8	3 1/4	3 3/4	13	1	15	1.4	45	5.8	9
1 1/2	1.50	1.50	6.12	0.81	2.88	2.75	3.25	6.12	4	0.88	4.50	3.25	2.75	1.00	3/4	3 1/2	4	15	1.2	21	1.9	61	7.8	9
2	2.00	1.94	6.50	0.88	3.62	3.31	3.94	6.50	8	0.75	5.00	3.94	3.31	0.88	5/8	3 1/2	4 1/4	20	1.5	28	2.6	68	8.5	9
2 1/2	2.50	2.32	7.50	1.00	4.12	3.94	4.62	7.50	8	0.88	5.88	4.62	3.94	1.00	3/4	4	4 1/2	25	2.1	38	3.6	89	11	9
3	3.00	2.90	8.25	1.12	5.00	4.62	5.38	8.25	8	0.88	6.62	5.38	4.62	1.00	3/4	4 1/4	5	35	2.7	49	4.6	106	13	9
3 1/2	3.50	3.36	9.00	1.19	5.50	5.25	6.00	9.00	8	0.88	7.25	6.00	5.25	1.00	3/4	4 1/4	5	42	3.4	59	5.5	122	15	9
4	4.00	3.83	10.00	1.25	6.19	5.75	6.62	10.00	8	0.88	7.88	6.62	5.75	1.00	3/4	4 1/2	5 1/4	62	3.8	91	6.5	207	19	12
5	5.00	4.81	11.00	1.38	7.31	7.00	8.00	11.00	8	0.88	9.25	8.00	7.00	1.00	3/4	4 3/4	5 1/4	84	5.3	124	9.1	241	21	12
6	6.00	5.76	12.50	1.44	8.50	8.12	9.38	12.50	12	0.88	10.62	9.38	8.12	1.00	3/4	4 3/4	5 3/4	105	6.7	165	12	303	27	12
8	8.00	7.62	15.00	1.62	10.62	10.25	11.56	15.00	12	1.00	13.00	11.56	10.25	1.12	7/8	5 1/2	6 1/4	148	9.1	228	17	405	36	12
10	10.00	9.56	17.50	1.88	12.75	12.62	13.62	17.50	16	1.12	15.25	13.62	12.62	1.25	1	6 1/4	7 1/4	210	13	291	21	499	46	12
12	12.00	11.38	20.50	2.00	15.00	14.75	15.94	20.50	16	1.25	17.75	15.94	14.75	1.38	1 1/8	6 3/4	7 1/2	275	16	392	28	651	61	12
14	14.00	14.00	23.00	2.12	16.25	16.75	18.44	23.00	20	1.25	20.25	18.44	16.75	1.38	1 1/8	7	7 3/4	324	19	456	32	785	74	12
16	16.00	16.00	25.50	2.25	18.50	19.00	20.50	25.50	20	1.38	22.50	20.50	19.00	1.50	1 1/4	7 1/2	8 1/2	404	23	529	37	914	88	12
18	18.00	18.00	28.00	2.38	21.00	21.00	22.75	28.00	24	1.38	24.75	22.75	21.00	1.50	1 1/4	7 3/4	8 1/4	465	26	630	43	1066	102	12
20	20.00	20.00	30.50	2.50	23.00	23.12	25.00	30.50	24	1.38	27.00	25.00	23.12	1.50	1 1/4	8 1/4	9 1/4	549	30	741	50	1228	118	12
24	24.00	24.00	36.00	2.75	27.25	27.62	29.62	36.00	24	1.62	32.00	29.62	27.62	1.75	1 1/2	9 1/4	10 1/4	778	42	1016	67	1627	160	12

For intermediate connections, see subcategory under Flange Dims/Weights at www.texasflange.com.

DIMENSIONS ARE IN INCHES | WEIGHTS ARE IN POUNDS



Class 400 Standard Connection Specifications

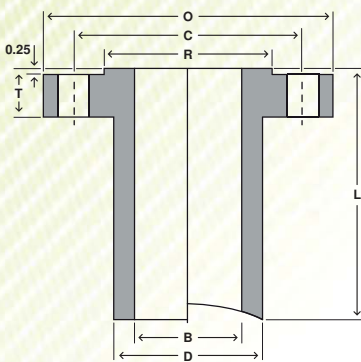

LONG WELD NECK "LWN"

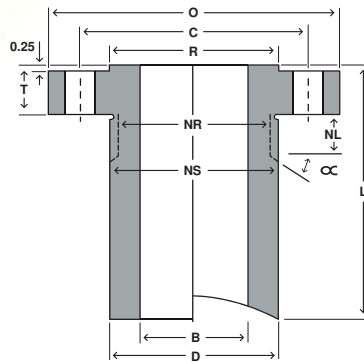

HEAVY BARREL "HB"

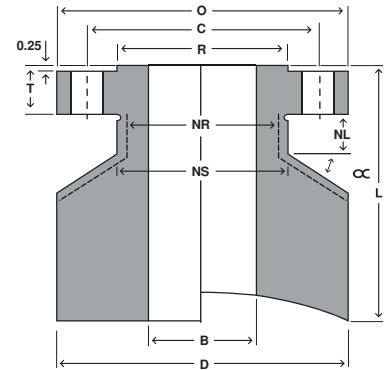

EQUAL BARREL "E"

Size			Flange			Barrel OD			Bolting			Nut			Stud Bolt			Weights						Length
Nom	Bore LWN & E	Bore HB	OD	Thk.	RF of OD	LWN	HB	E	# of Holes	Hole Size	Bolt Circle	Stop Dia	Relief Dia	Relief Length	Size	RF Length	RTJ Length	LWN		HB		E		Base
	B	B	O	T	R	D	D	D			C	NS	NR	NL				Base	Per 1"	Base	Per 1"	Base	Per 1"	L
1/2	0.50	0.55	3.75	0.56	1.38	1.50	1.75	3.75	4	0.62	2.62	1.75	1.50	0.75	1/2	3	3	5	0.4	7	0.6	24	3.1	9
3/4	0.75	0.74	4.62	0.62	1.69	1.88	2.19	4.62	4	0.75	3.25	2.19	1.88	0.88	5/8	3 1/2	3 1/2	8	0.7	11	0.9	37	4.6	9
1	1.00	0.96	4.88	0.69	2.00	2.12	2.44	4.88	4	0.75	3.50	2.44	2.12	0.88	5/8	3 1/2	3 1/2	9	0.8	12	1.1	40	5.1	9
1 1/4	1.25	1.28	5.25	0.81	2.50	2.50	2.81	5.25	4	0.75	3.88	2.81	2.50	0.88	5/8	3 3/4	3 3/4	13	1	15	1.4	45	5.8	9
1 1/2	1.50	1.50	6.12	0.88	2.88	2.75	3.25	6.12	4	0.88	4.50	3.25	2.75	1.00	3/4	4 1/4	4 1/4	16	1.2	21	1.9	61	7.8	9
2	2.00	1.94	6.50	1.00	3.62	3.31	3.94	6.50	8	0.75	5.00	3.94	3.31	0.88	5/8	4 1/4	4 1/4	20	1.5	29	2.6	68	8.5	9
2 1/2	2.50	2.32	7.50	1.12	4.12	3.94	4.63	7.50	8	0.88	5.88	4.63	3.94	1.00	3/4	4 3/4	4 3/4	27	2.1	39	3.6	88	11	9
3	3.00	2.90	8.25	1.25	5.00	4.62	5.38	8.25	8	0.88	6.62	5.38	4.62	1.00	3/4	5	5	36	2.7	50	4.6	104	13	9
3 1/2	3.50	3.36	9.00	1.38	5.50	5.25	5.81	9.00	8	1.00	7.25	5.81	5.25	1.12	7/8	5 1/2	5 1/2	45	3.4	61	5.5	116	15	9
4	4.00	3.83	10.00	1.38	6.19	5.75	6.44	10.00	8	1.00	7.88	6.44	5.75	1.12	7/8	5 1/2	5 1/2	65	3.8	93	6.5	197	19	12
5	5.00	4.81	11.00	1.50	7.31	7.00	7.81	11.00	8	1.00	9.25	7.81	7.00	1.12	7/8	5 3/4	5 3/4	88	5.3	127	9.1	229	22	12
6	6.00	5.76	12.50	1.62	8.50	8.12	9.19	12.50	12	1.00	10.62	9.19	8.12	1.12	7/8	6	6	110	6.7	169	12	286	27	12
8	8.00	7.62	15.00	1.88	10.62	10.25	11.38	15.00	12	1.12	13.00	11.38	10.25	1.25	1	6 3/4	6 3/4	154	9.1	233	17	379	36	12
10	10.00	9.56	17.50	2.12	12.75	12.62	13.44	17.50	16	1.25	15.25	13.44	12.62	1.38	1 1/8	7 1/2	7 1/2	218	13	298	21	475	46	12
12	12.00	11.38	20.50	2.25	15.00	14.75	15.75	20.50	16	1.38	17.75	15.75	14.75	1.50	1 1/4	8	8	285	16	401	28	627	62	12
14	14.00	14.00	23.00	2.38	16.25	16.75	18.25	23.00	20	1.38	20.25	18.25	16.75	1.50	1 1/4	8 1/4	8 1/4	336	19	467	32	758	74	12
16	16.00	16.00	25.50	2.50	18.50	19.00	20.31	25.50	20	1.50	22.50	20.31	19.00	1.62	1 3/8	8 3/4	8 3/4	418	23	542	37	884	88	12
18	18.00	18.00	28.00	2.62	21.00	21.00	22.56	28.00	24	1.50	24.75	22.56	21.00	1.62	1 3/8	9	9	482	26	645	43	1033	102	12
20	20.00	20.00	30.50	2.75	23.00	23.12	24.63	30.50	24	1.62	27.00	24.63	23.12	1.75	1 1/2	9 1/2	9 3/4	568	30	759	50	1165	118	12
24	24.00	24.00	36.00	3.00	27.25	27.62	29.25	36.00	24	1.88	32.00	29.25	27.62	2.00	1 3/4	10 1/2	11	804	42	1040	67	1540	160	12

For intermediate connections, see subcategory under Flange Dims/Weights at www.texasflange.com.

DIMENSIONS ARE IN INCHES | WEIGHTS ARE IN POUNDS



Class 600 Standard Connection Specifications

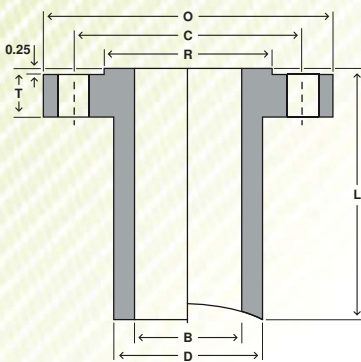

LONG WELD NECK "LWN"

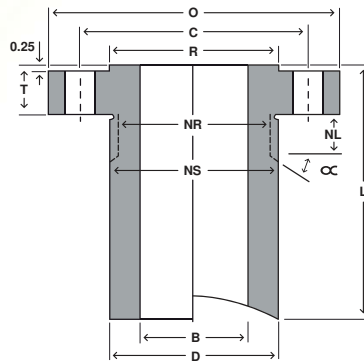

HEAVY BARREL "HB"

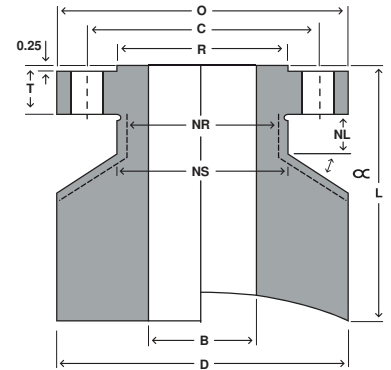

EQUAL BARREL "E"

Size		Flange				Barrel OD			Bolting			Nut			Stud Bolt			Weights						Length
Nom	Bore LWN & E	Bore HB	OD	Thk	RF of OD	LWN	HB	E	# of Holes	Hole Size	Bolt Circle	Stop Dia	Relief Dia	Relief Length	Size	RF Length	RTJ Length	LWN		HB		E		Base
	B	B	O	T	R	D	D	D			C	NS	NR	NL				Base	Per 1"	Base	Per 1"	Base	Per 1"	L
1/2	0.50	0.55	3.75	0.56	1.38	1.50	1.75	3.75	4	0.62	2.62	1.75	1.50	0.75	1/2	3	3	5	0.4	7	0.6	24	3.1	9
3/4	0.75	0.74	4.62	0.62	1.69	1.88	2.19	4.62	4	0.75	3.25	2.19	1.88	0.88	5/8	3 1/2	3 1/2	8	0.7	11	0.9	36	4.6	9
1	1.00	0.96	4.88	0.69	2.00	2.12	2.44	4.88	4	0.75	3.50	2.44	2.12	0.88	5/8	3 1/2	3 1/2	9	0.8	12	1.1	39	5.1	9
1 1/4	1.25	1.28	5.25	0.81	2.50	2.50	2.81	5.25	4	0.75	3.88	2.81	2.50	0.88	5/8	3 3/4	3 3/4	13	1	15	1.4	44	5.8	9
1 1/2	1.50	1.50	6.12	0.88	2.88	2.75	3.25	6.12	4	0.88	4.50	3.25	2.75	1.00	3/4	4 1/4	4 1/4	16	1.2	21	1.9	59	7.8	9
2	2.00	1.94	6.50	1.00	3.62	3.31	3.94	6.50	8	0.75	5.00	3.94	3.31	0.88	5/8	4 1/4	4 1/4	20	1.5	29	2.6	67	8.5	9
2 1/2	2.50	2.32	7.50	1.12	4.12	3.94	4.62	7.50	8	0.88	5.88	4.62	3.94	1.00	3/4	5	4 3/4	27	2.1	39	3.6	85	11	9
3	3.00	2.90	8.25	1.25	5.00	4.62	5.38	8.25	8	0.88	6.62	5.38	4.62	1.00	3/4	5	5 1/4	36	2.7	50	4.6	104	13	9
3 1/2	3.50	3.36	9.00	1.38	5.50	5.25	5.81	9.00	8	1.00	7.25	5.81	5.25	1.12	7/8	5 1/2	5 1/2	45	3.4	57	5	116	15	9
4	4.00	3.83	10.75	1.50	6.19	6.00	7.06	10.75	8	1.00	8.50	7.06	6.00	1.12	7/8	5 3/4	6	77	4.5	113	7.8	238	22	12
5	5.00	4.81	13.00	1.75	7.31	7.50	8.88	13.00	8	1.12	10.50	8.88	7.50	1.25	1	6 1/2	6 1/2	123	7	180	12	336	32	12
6	6.00	5.76	14.00	1.88	8.50	8.75	9.88	14.00	12	1.12	11.50	9.88	8.75	1.25	1	6 3/4	7	152	9	207	14	373	36	12
8	8.00	7.62	16.50	2.19	10.62	10.75	11.94	16.50	12	1.25	13.75	11.94	10.75	1.38	1 1/8	7 3/4	8	207	11	277	19	478	46	12
10	10.00	9.56	20.00	2.50	12.75	13.50	15.00	20.00	16	1.38	17.00	15.00	13.50	1.50	1 1/4	8 1/2	8 3/4	324	18	433	30	683	67	12
12	12.00	11.38	22.00	2.62	15.00	15.75	17.25	22.00	20	1.38	19.25	17.25	15.75	1.50	1 1/4	8 3/4	9	393	23	533	37	779	76	12
14	14.00	14.00	23.75	2.75	16.25	17.00	18.56	23.75	20	1.50	20.75	18.56	17.00	1.62	1 3/8	9 1/4	9 1/2	471	21	631	33	1149	82	16
16	16.00	16.00	27.00	3.00	18.50	19.50	21.38	27.00	20	1.62	23.75	21.38	19.50	1.75	1 1/2	10	10 1/4	638	28	856	45	1471	105	16
18	18.00	18.00	29.25	3.25	21.00	21.50	23.19	29.25	20	1.75	25.75	23.19	21.50	1.88	1 5/8	10 3/4	11	731	31	941	48	1628	118	16
20	20.00	20.00	32.00	3.50	23.00	24.00	25.94	32.00	24	1.75	28.50	25.94	24.00	1.88	1 5/8	11 1/2	11 3/4	916	39	1180	61	1920	139	16
24	24.00	24.00	37.00	4.00	27.25	28.25	30.06	37.00	24	2.00	33.00	30.06	28.25	2.12	1 7/8	13	13 1/2	1210	49	1486	73	2376	176	16

For intermediate connections, see subcategory under Flange Dims/Weights at www.texasflange.com.

DIMENSIONS ARE IN INCHES | WEIGHTS ARE IN POUNDS



Class 900 Standard Connection Specifications

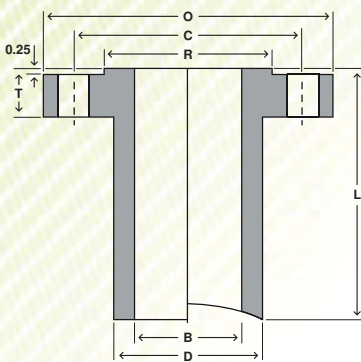

LONG WELD NECK "LWN"

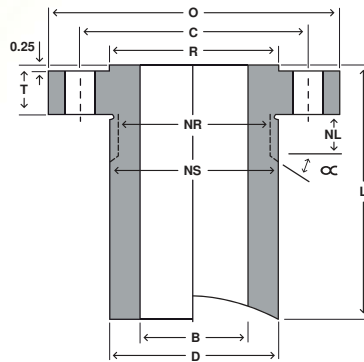

HEAVY BARREL "HB"

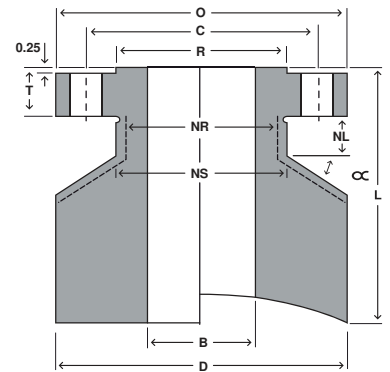

EQUAL BARREL "E"

Size		Flange			Barrel OD			Bolting			Nut			Stud Bolt			Weights					Length				
Nom	Bore LWN & E	Bore HB	OD	Thk	RF of OD	LWN	HB	E	# of Holes	Hole Size	Bolt Circle	Stop Dia	Relief Dia	Relief Length	Size	RF Length	RTJ Length	Base	Per 1"	Base	Per 1"	Base	Per 1"	Base	Per 1"	L
	B	B	O	T	R	D	D	D			C	NS	NR	NL				Base	Per 1"	Base	Per 1"	Base	Per 1"	Base	Per 1"	L
1/2	0.50	0.55	4.75	0.88	1.38	1.56	2.00	4.75	4	0.88	3.25	2.00	1.56	1.00	3/4	4 1/4	4 1/4	8	0.5	10	0.8	37	5	9	9	
3/4	0.75	0.74	5.12	1.00	1.69	1.81	2.25	5.12	4	0.88	3.50	2.25	1.81	1.00	3/4	4 1/2	4 1/2	10	0.6	13	1	42	5.7	9	9	
1	1.00	0.96	5.88	1.12	2.00	2.12	2.56	5.88	4	1.00	4.00	2.56	2.12	1.12	7/8	5	5	13	0.8	17	1.3	54	7.5	9	9	
1 1/4	1.25	1.28	6.25	1.12	2.50	2.50	2.94	6.25	4	1.00	4.38	2.94	2.50	1.12	7/8	5	5	17	1	20	1.6	61	8.3	9	9	
1 1/2	1.50	1.50	7.00	1.25	2.88	2.75	3.25	7.00	4	1.12	4.88	3.25	2.75	1.25	1	5 1/2	5 1/2	21	1.2	26	1.9	77	10	9	9	
2	2.00	1.94	8.50	1.50	3.62	4.12	5.06	8.50	8	1.00	6.50	5.06	4.12	1.12	7/8	5 3/4	5 3/4	42	2.9	56	4.9	115	15	9	9	
2 1/2	2.50	2.32	9.62	1.62	4.12	4.88	5.88	9.62	8	1.12	7.50	5.88	4.88	1.25	1	6 1/4	6 1/4	56	3.9	75	6.5	144	19	9	9	
3	3.00	2.90	9.50	1.50	5.00	5.00	6.06	9.50	8	1.00	7.50	6.06	5.00	1.12	7/8	5 3/4	5 3/4	51	3.6	71	6.3	139	18	9	9	
4	4.00	3.83	11.50	1.75	6.19	6.25	7.44	11.50	8	1.25	9.25	7.44	6.25	1.38	1 1/8	6 3/4	6 3/4	93	5.1	133	9.1	270	26	12	12	
5	5.00	4.81	13.75	2.00	7.31	7.50	9.00	13.75	8	1.38	11.00	9.00	7.50	1.50	1 1/4	7 1/2	7 1/2	135	7	194	13	376	37	12	12	
6	6.00	5.76	15.00	2.19	8.50	9.25	10.69	15.00	12	1.25	12.50	10.69	9.25	1.38	1 1/8	7 1/2	7 3/4	191	11	259	18	436	42	12	12	
8	8.00	7.62	18.50	2.50	10.62	11.75	13.31	18.50	12	1.50	15.50	13.31	11.75	1.62	1 3/8	8 3/4	8 3/4	297	16	389	27	626	62	12	12	
10	10.00	9.56	21.50	2.75	12.75	14.50	16.31	21.50	16	1.50	18.50	16.31	14.50	1.62	1 3/8	9 1/4	9 1/4	422	25	558	39	824	81	12	12	
12	12.00	11.38	24.00	3.12	15.00	16.50	18.81	24.00	20	1.50	21.00	18.81	16.50	1.62	1 3/8	10	10	518	29	715	50	984	96	12	12	
14	14.00	14.00	25.25	3.38	16.25	17.75	19.62	25.25	20	1.62	22.00	19.62	17.75	1.75	1 1/2	10 3/4	11	624	26	817	42	1368	98	16	16	
16	16.00	16.00	27.75	3.50	18.50	20.00	21.69	27.75	20	1.75	24.25	21.69	20.00	1.88	1 5/8	11 1/4	11 1/2	750	32	942	48	1573	114	16	16	
18	18.00	18.00	31.00	4.00	21.00	22.25	24.06	31.00	20	2.00	27.00	24.06	22.25	2.12	1 7/8	12 3/4	13 1/4	950	38	1169	57	1898	142	16	16	
20	20.00	20.00	33.75	4.25	23.00	24.50	26.38	33.75	20	2.12	29.50	26.38	24.50	2.25	2	13 3/4	14 1/4	1121	43	1378	66	2182	164	16	16	
24	24.00	24.00	41.00	5.50	27.25	29.50	31.62	41.00	20	2.62	35.50	31.62	29.50	2.75	2 1/2	17 1/4	18	1865	65	2160	94	3084	246	16	16	

For intermediate connections, see subcategory under Flange Dims/Weights at www.texasflange.com.

DIMENSIONS ARE IN INCHES | WEIGHTS ARE IN POUNDS



Class 1500 Standard Connection Specifications

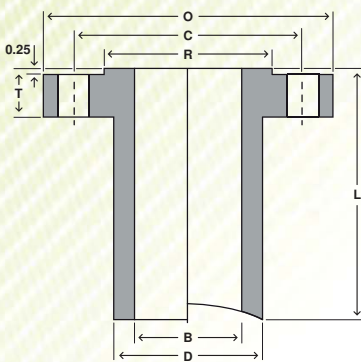

LONG WELD NECK "LWN"

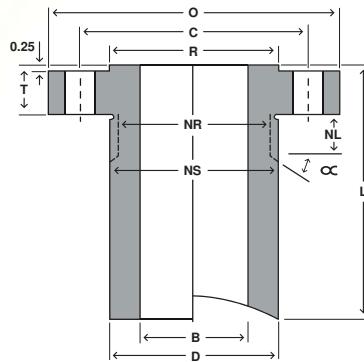

HEAVY BARREL "HB"

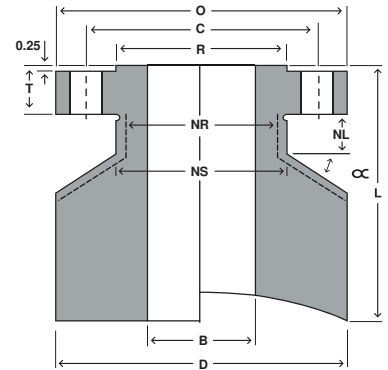

EQUAL BARREL "E"

Size		Flange			Barrel OD			Bolting			Nut			Stud Bolt			Weights					Length		
Nom	Bore LWN & E	Bore HB	OD	Thk	RF of OD	LWN	HB	E	# of Holes	Hole Size	Bolt Circle	Stop Dia	Relief Dia	Relief Length	Size	RF Length	RTJ Length	LWN		HB		E		Base
	B	B	O	T	R	D	D	D			C	NS	NR	NL				Base	Per 1"	Base	Per 1"	Base	Per 1"	L
1/2	0.50	0.55	4.75	0.88	1.38	1.56	2.00	4.75	4	0.88	3.25	2.00	1.56	1.00	3/4	4 1/4	4 1/4	8	0.5	10	0.8	37	5	9
3/4	0.75	0.74	5.12	1.00	1.69	1.81	2.25	5.12	4	0.88	3.50	2.25	1.81	1.00	3/4	4 1/2	4 1/2	10	0.6	13	1	42	5.7	9
1	1.00	0.96	5.88	1.12	2.00	2.12	2.56	5.88	4	1.00	4.00	2.56	2.12	1.12	7/8	5	5	13	0.8	17	1.3	54	7.5	9
1 1/4	1.25	1.28	6.25	1.12	2.50	2.50	2.94	6.25	4	1.00	4.38	2.94	2.50	1.12	7/8	5	5	17	1	20	1.6	61	8.3	9
1 1/2	1.50	1.50	7.00	1.25	2.88	2.75	3.25	7.00	4	1.12	4.88	3.25	2.75	1.25	1	5 1/2	5 1/2	21	1.2	26	1.9	77	10	9
2	2.00	1.94	8.50	1.50	3.62	4.12	5.06	8.50	8	1.00	6.50	5.06	4.12	1.12	7/8	5 3/4	5 3/4	42	2.9	56	4.9	115	15	9
2 1/2	2.50	2.32	9.62	1.62	4.12	4.88	5.88	9.62	8	1.12	7.50	5.88	4.88	1.25	1	6 1/4	6 1/4	56	3.9	75	6.5	144	19	9
3	3.00	2.90	10.50	1.88	5.00	5.25	6.19	10.50	8	1.25	8.00	6.19	5.25	1.38	1 1/8	7	7	67	4.1	84	6.7	161	23	9
4	4.00	3.83	12.25	2.12	6.19	6.38	7.50	12.25	8	1.38	9.50	7.50	6.38	1.50	1 1/4	7 3/4	7 3/4	110	5.5	147	9.3	302	30	12
5	5.00	4.81	14.75	2.88	7.31	7.75	9.12	14.75	8	1.62	11.50	9.12	7.75	1.75	1 1/2	9 3/4	9 3/4	181	7.8	233	13	414	43	12
6	6.00	5.76	15.50	3.25	8.50	9.00	10.31	15.50	12	1.50	12.50	10.31	9.00	1.62	1 3/8	10 1/4	10 1/2	215	10	272	16	445	46	12
8	8.00	7.62	19.00	3.62	10.62	11.50	12.94	19.00	12	1.75	15.50	12.94	11.50	1.88	1 5/8	11 1/2	12 3/4	337	15	417	24	629	67	12
10	10.00	9.56	23.00	4.25	12.75	14.50	16.06	23.00	12	2.00	19.00	16.06	14.50	2.12	1 7/8	13 1/4	13 1/2	546	25	651	37	888	97	12
12	12.00	11.38	26.50	4.88	15.00	17.75	19.38	26.50	16	2.12	22.50	19.38	17.75	2.25	2	14 3/4	15 1/4	946	38	1148	55	1683	127	16
14	14.00	14.00	29.50	5.25	16.25	19.50	21.50	29.50	16	2.38	25.00	21.50	19.50	2.50	2 1/4	16	16 3/4	1116	41	1308	59	1929	150	16
16	16.00	16.00	32.50	5.75	18.50	21.75	23.88	32.50	16	2.62	27.75	23.88	21.75	2.75	2 1/2	17 1/2	18 1/2	1371	48	1588	70	2238	178	16
18	18.00	18.00	36.00	6.38	21.00	23.50	26.25	36.00	16	2.88	30.50	26.25	23.50	3.00	2 3/4	19 1/2	20 3/4	1674	51	1959	81	2629	216	16
20	20.00	20.00	38.75	7.00	23.00	25.25	28.12	38.75	16	3.12	32.75	28.12	25.25	3.25	3	21 1/4	22 1/4	1943	53	2241	87	2868	245	16
24	24.00	24.00	46.00	8.00	27.25	30.00	33.62	46.00	16	3.62	39.00	33.62	30.00	3.75	3 1/2	24 1/4	25 1/2	2936	72	3334	123	3819	343	16

For intermediate connections, see subcategory under Flange Dims/Weights at www.texasflange.com.

DIMENSIONS ARE IN INCHES | WEIGHTS ARE IN POUNDS



Class 2500 Standard Connection Specifications

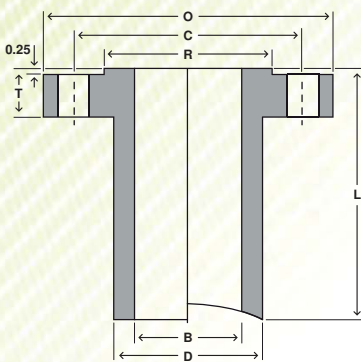

LONG WELD NECK "LWN"

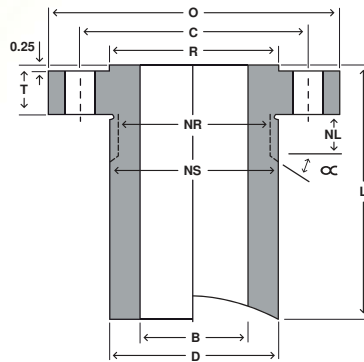

HEAVY BARREL "HB"

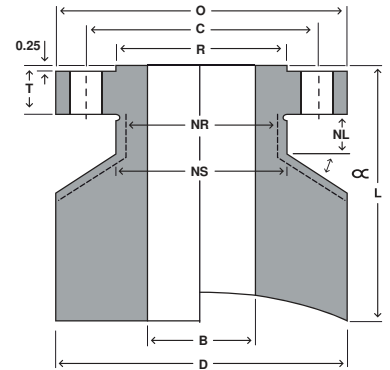

EQUAL BARREL "E"

Size		Flange			Barrel OD			Bolting			Nut			Stud Bolt			Weights					Length		
Nom	Bore LWN & E	Bore HB	OD	Thk	RF of OD	LWN	HB	E	# of Holes	Hole Size	Bolt Circle	Stop Dia	Relief Dia	Relief Length	Size	RF Length	RTJ Length	LWN		HB		E		Base
	B	B	O	T	R	D	D	D			C	NS	NR	NL				Base	Per 1"	Base	Per 1"	Base	Per 1"	L
1/2	0.50	0.55	5.25	1.19	1.38	1.81	2.25	5.25	4	0.88	3.50	2.25	1.81	1.00	3/4	4 3/4	4 3/4	11	0.7	14	1.1	45	6.1	9
3/4	0.75	0.74	5.50	1.25	1.69	2.06	2.50	5.50	4	0.88	3.75	2.50	2.06	1.00	3/4	5	5	13	0.8	17	1.3	49	6.6	9
1	1.00	0.96	6.25	1.38	2.00	2.25	2.81	6.25	4	1.00	4.25	2.81	2.25	1.12	7/8	5 1/2	5 1/2	18	0.9	22	1.6	62	8.5	9
1 1/4	1.25	1.28	7.25	1.50	2.50	2.88	3.50	7.25	4	1.12	5.12	3.50	2.88	1.25	1	6	6	27	1.5	32	2.4	84	11	9
1 1/2	1.50	1.50	8.00	1.75	2.88	3.12	3.94	8.00	4	1.25	5.75	3.94	3.12	1.38	1 1/8	6 3/4	6 3/4	33	1.7	42	3	94	14	9
2	2.00	1.94	9.25	2.00	3.62	3.75	5.12	9.25	8	1.12	6.75	5.12	3.75	1.25	1	7	7	48	2.2	66	5	131	18	9
2 1/2	2.50	2.32	10.50	2.25	4.12	4.50	5.94	10.50	8	1.25	7.75	5.94	4.50	1.38	1 1/8	7 3/4	8	66	3.1	90	6.7	165	23	9
3	3.00	2.90	12.00	2.62	5.00	5.25	7.00	12.00	8	1.38	9.00	7.00	5.25	1.50	1 1/4	8 3/4	9	97	4.1	127	9	210	30	9
4	4.00	3.83	14.00	3.00	6.19	6.50	8.38	14.00	8	1.62	10.75	8.38	6.50	1.75	1 1/2	10	10 1/4	159	5.8	218	12	391	40	12
5	5.00	4.81	16.50	3.62	7.31	8.00	10.00	16.50	8	1.88	12.75	10.00	8.00	2.00	1 3/4	11 3/4	12 1/4	248	8.7	319	17	518	55	12
6	6.00	5.76	19.00	4.25	8.50	9.25	11.38	19.00	8	2.12	14.50	11.38	9.25	2.25	2	13 1/2	14	358	11	441	21	641	73	12
8	8.00	7.62	21.75	5.00	10.62	12.00	14.12	21.75	12	2.12	17.25	14.12	12.00	2.25	2	15	15 1/2	589	18	743	31	1167	92	16
10	10.00	9.56	26.50	6.50	12.75	14.75	17.38	26.50	12	2.62	21.25	17.38	14.75	2.75	2 1/2	19 1/4	20	997	26	1202	47	1625	134	16
12	12.00	11.38	30.00	7.25	15.00	17.38	20.12	30.00	12	2.88	24.38	20.12	17.38	3.00	2 3/4	21 1/4	22	1363	35	1609	61	1995	168	16

For intermediate connections, see subcategory under Flange Dims/Weights at www.texasflange.com.

DIMENSIONS ARE IN INCHES | WEIGHTS ARE IN POUNDS



Class 150 Studding Outlets

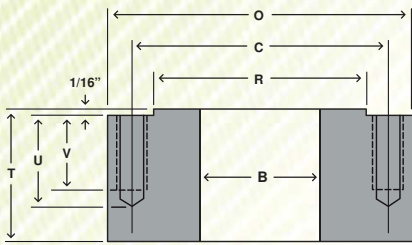

FLAT BOTTOM

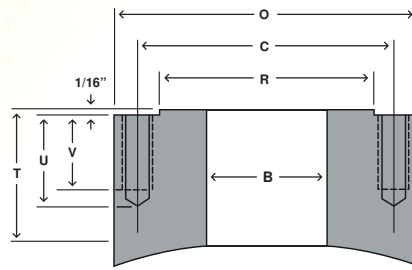

SHELL / HEAD MOUNT

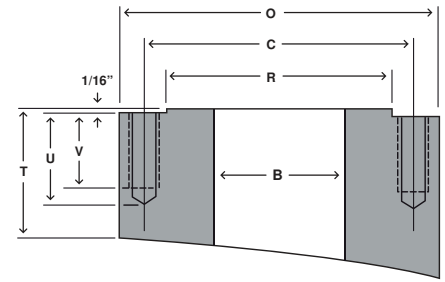

TANGENTIAL MOUNT

Bore	OD	Thickness	OD of RF	Stud Circle	Hole Dia	# of Holes	Hole Depth	Tap Size	T.P.I.	Tap Depth	Flat Bottom Weight	
B	O	T	R	C			U			V	Base	per 1"
1/2	3.50	1.25	1.38	2.38	27/64	4	0.88	1/2	13	0.56	3	2.7
3/4	3.88	1.25	1.69	2.75	27/64	4	0.88	1/2	13	0.56	3.7	3.2
1	4.25	1.25	2.00	3.12	27/64	4	0.88	1/2	13	0.56	4.3	3.8
1 1/4	4.62	1.25	2.50	3.50	27/64	4	0.88	1/2	13	0.56	5.1	4.4
1 1/2	5.00	1.25	2.88	3.88	27/64	4	0.88	1/2	13	0.56	5.9	5.1
2	6.00	1.50	3.62	4.75	17/32	4	1.12	5/8	11	0.75	10.2	7.1
2 1/2	7.00	1.50	4.12	5.50	17/32	4	1.12	5/8	11	0.75	14	9.5
3	7.50	1.50	5.00	6.00	17/32	4	1.12	5/8	11	0.75	15	11
3 1/2	8.50	1.50	5.50	7.00	17/32	8	1.12	5/8	11	0.75	19	13
4	9.00	1.50	6.19	7.50	17/32	8	1.12	5/8	11	0.75	20	14
5	10.00	1.75	7.31	8.50	21/32	8	1.31	3/4	10	0.88	28	17
6	11.00	1.75	8.50	9.50	21/32	8	1.31	3/4	10	0.88	31	19
8	13.50	1.75	10.62	11.75	21/32	8	1.31	3/4	10	0.88	46	26
10	16.00	1.81	12.75	14.25	49/64	12	1.44	7/8	9	1.00	58	35
12	19.00	1.81	15.00	17.00	49/64	12	1.44	7/8	9	1.00	83	48
14	21.00	2.00	16.25	18.75	7/8	12	1.56	1	8	1.12	102	55
16	23.50	2.00	18.50	21.25	7/8	16	1.56	1	8	1.12	123	66
18	25.00	2.25	21.00	22.75	1	16	1.81	1 1/8	8	1.25	140	67
20	27.50	2.25	23.00	25.00	1	20	1.81	1 1/8	8	1.25	166	79
24	32.00	2.50	27.25	29.50	1 1/8	20	2.12	1 1/4	8	1.44	231	100

DIMENSIONS ARE IN INCHES | WEIGHTS ARE IN POUNDS

MATERIAL: Studding Outlets are most commonly provided in SA-105. they can also be made from a full range of stainless and alloy materials

THICKNESS: The standard thickness shown above for all studding outlets is the minimum required per ASME section V111 division 1 paragraph UG-43(d) for thread engagement and an ID mount. It is important to note that each individual application should be analyzed for proper thickness

FACING: The studding outlet minimum thickness "T" includes proper raised face per ANSI B16.5. Outlets can be supplied with any special facing as needed upon request.

DRILLING AND TAPPING: Studding outlets are furnished to ANSI B16.5 specifications unless otherwise specified. Thread depth is in accordance with ASME section V111 Division 1 Para. UG-43(g) for a design temperature not to exceed 650°F, a base metal stress of 17,500 psi(g), and a stud stress of 25,000 psi(g). All other materials exceeding these stresses should be checked for UG-43 compliance

BORE: Bore sizes shown above are standard. Other sizes can be furnished upon request

CURVING: All connections can be furnished contoured to fit any shell, head, or cone at an additional cost. Specify diameter to be mounted



Class 300 Studding Outlets

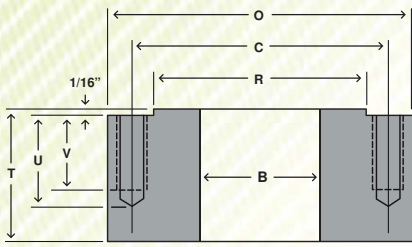

FLAT BOTTOM

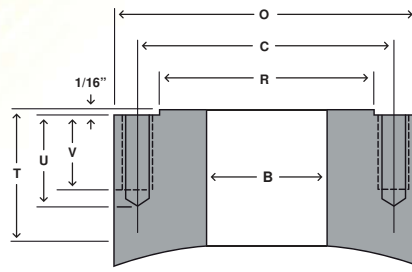

SHELL / HEAD MOUNT

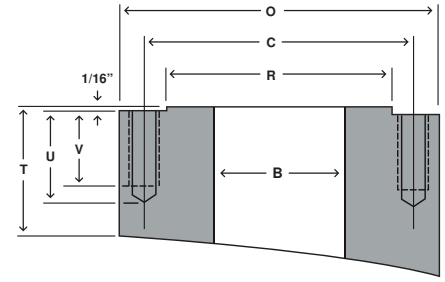

TANGENTIAL MOUNT

Bore	OD	Thickness	OD of RF	Stud Circle	Hole Dia	# of Holes	Hole Depth	Tap Size	T.P.I.	Tap Depth	Flat Bottom Weight	
B	O	T	R	C			U			V	Base	per 1"
1/2	3.75	1.25	1.38	2.62	27/64	4	0.88	1/2	13	0.56	3.5	3.1
3/4	4.62	1.50	1.69	3.25	17/32	4	1.12	5/8	11	0.75	6.4	4.6
1	4.88	1.50	2.00	3.50	17/32	4	1.12	5/8	11	0.75	7	5.1
1 1/4	5.25	1.50	2.50	3.88	17/32	4	1.12	5/8	11	0.75	8	5.8
1 1/2	6.12	1.75	2.88	4.50	21/32	4	1.31	3/4	10	0.88	13	7.8
2	6.50	1.50	3.62	5.00	17/32	8	1.12	5/8	11	0.75	12	8.5
2 1/2	7.50	1.75	4.12	5.88	21/32	8	1.31	3/4	10	0.88	18	11
3	8.25	1.75	5.00	6.62	21/32	8	1.31	3/4	10	0.88	22	14
3 1/2	9.00	1.75	5.50	7.25	21/32	8	1.31	3/4	10	0.88	25	15
4	10.00	1.75	6.19	7.88	21/32	8	1.31	3/4	10	0.88	30	19
5	11.00	1.75	7.31	9.25	21/32	8	1.31	3/4	10	0.88	36	21
6	12.50	1.75	8.50	10.62	21/32	12	1.31	3/4	10	0.88	44	27
8	15.00	1.88	10.62	13.00	49/64	12	1.44	7/8	9	1.00	63	36
10	17.50	2.12	12.75	15.25	7/8	16	1.56	1	8	1.12	90	46
12	20.50	2.25	15.00	17.75	1	16	1.81	1 1/8	8	1.25	127	61
14	23.00	2.25	16.25	20.25	1	20	1.81	1 1/8	8	1.25	153	74
16	25.50	2.50	18.50	22.50	1 1/8	20	2.12	1 1/4	8	1.44	201	88
18	28.00	2.50	21.00	24.75	1 1/8	24	2.12	1 1/4	8	1.44	235	102
20	30.50	2.50	23.00	27.00	1 1/8	24	2.12	1 1/4	8	1.44	273	118
24	36.00	2.88	27.25	32.00	1 3/8	24	2.38	1 1/2	8	1.69	425	160

DIMENSIONS ARE IN INCHES | WEIGHTS ARE IN POUNDS

MATERIAL: Studding Outlets are most commonly provided in SA-105. they can also be made from a full range of stainless and alloy materials

THICKNESS: The standard thickness shown above for all studding outlets is the minimum required per ASME section V111 division 1 paragraph UG-43(d) for thread engagement and an ID mount. It is important to note that each individual application should be analyzed for proper thickness

FACING: The studding outlet minimum thickness "T" includes proper raised face per ANSI B16.5. Outlets can be supplied with any special facing as needed upon request.

DRILLING AND TAPPING: Studding outlets are furnished to ANSI B16.5 specifications unless otherwise specified. Thread depth is in accordance with ASME section V111 Division 1 Para. UG-43(g) for a design temperature not to exceed 650°F, a base metal stress of 17,500 psi(g), and a stud stress of 25,000 psi(g). All other materials exceeding these stresses should be checked for UG-43 compliance

BORE: Bore sizes shown above are standard. Other sizes can be furnished upon request

CURVING: All connections can be furnished contoured to fit any shell, head, or cone at an additional cost. Specify diameter to be mounted



Class 600 Studding Outlets

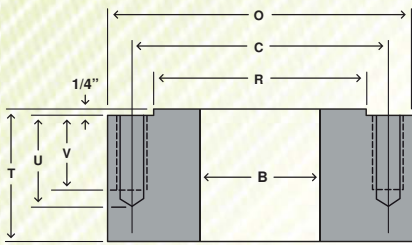

FLAT BOTTOM

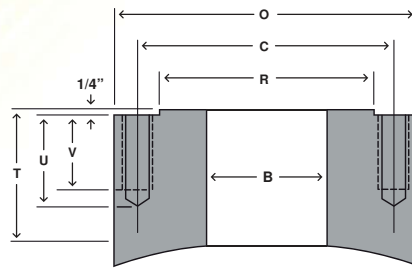

SHELL / HEAD MOUNT

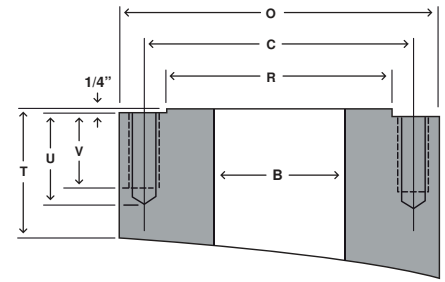

TANGENTIAL MOUNT

Bore	OD	Thickness	OD of RF	Stud Circle	Hole Dia	# of Holes	Hole Depth	Tap Size	T.P.I.	Tap Depth	Flat Bottom Weight	
B	O	T	R	C			U			V	Base	per 1"
1/2	3.75	1.50	1.38	2.62	27/64	4	0.88	1/2	13	0.56	3.8	3.1
3/4	4.62	1.75	1.69	3.25	17/32	4	1.12	5/8	11	0.75	6.7	4.6
1	4.88	1.75	2.00	3.50	17/32	4	1.12	5/8	11	0.75	7.4	5.1
1 1/4	5.25	1.75	2.50	3.88	17/32	4	1.12	5/8	11	0.75	8.6	5.8
1 1/2	6.12	1.94	2.88	4.50	21/32	4	1.31	3/4	10	0.88	13	7.8
2	6.50	1.75	3.62	5.00	17/32	8	1.12	5/8	11	0.75	12	8.5
2 1/2	7.50	2.00	4.12	5.88	21/32	8	1.31	3/4	10	0.88	19	11
3	8.25	2.00	5.00	6.62	21/32	8	1.31	3/4	10	0.88	23	13
3 1/2	9.00	2.12	5.50	7.25	49/64	8	1.44	7/8	9	1.00	28	15
4	10.75	2.12	6.19	8.50	49/64	8	1.44	7/8	9	1.00	41	22
5	13.00	2.25	7.31	10.50	7/8	8	1.56	1	8	1.12	63	32
6	14.00	2.25	8.50	11.50	7/8	12	1.56	1	8	1.12	68	36
8	16.50	2.50	10.62	13.75	1	12	1.81	1 1/8	8	1.25	101	46
10	20.00	2.75	12.75	17.00	1 1/8	16	2.12	1 1/4	8	1.44	160	67
12	22.00	2.75	15.00	19.25	1 1/8	20	2.12	1 1/4	8	1.44	180	76
14	23.75	2.88	16.25	20.75	1 1/4	20	2.25	1 3/8	8	1.56	201	82
16	27.00	3.00	18.50	23.75	1 3/8	20	2.38	1 1/2	8	1.69	271	105
18	29.25	3.25	21.00	25.75	1 1/2	20	2.56	1 5/8	8	1.88	331	118
20	32.00	3.25	23.00	28.50	1 1/2	24	2.56	1 5/8	8	1.88	387	139
24	37.00	3.75	27.25	33.00	1 3/4	24	3.00	1 7/8	8	2.12	571	176

DIMENSIONS ARE IN INCHES | WEIGHTS ARE IN POUNDS

MATERIAL: Studding Outlets are most commonly provided in SA-105. they can also be made from a full range of stainless and alloy materials

THICKNESS: The standard thickness shown above for all studding outlets is the minimum required per ASME section V111 division 1 paragraph UG-43(d) for thread engagement and an ID mount. It is important to note that each individual application should be analyzed for proper thickness

FACING: The studding outlet minimum thickness "T" includes proper raised face per ANSI B16.5. Outlets can be supplied with any special facing as needed upon request.

DRILLING AND TAPPING: Studding outlets are furnished to ANSI B16.5 specifications unless otherwise specified. Thread depth is in accordance with ASME section V111 Division 1 Para. UG-43(g) for a design temperature not to exceed 650°F, a base metal stress of 17,500 psi (g), and a stud stress of 25,000 psi (g). All other materials exceeding these stresses should be checked for UG-43 compliance

BORE: Bore sizes shown above are standard. Other sizes can be furnished upon request

CURVING: All connections can be furnished contoured to fit any shell, head, or cone at an additional cost. Specify diameter to be mounted



Class 900 Studding Outlets

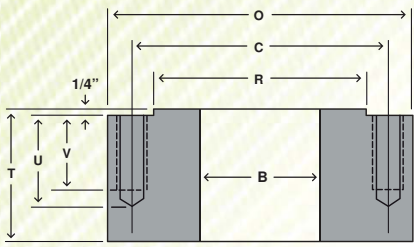

FLAT BOTTOM

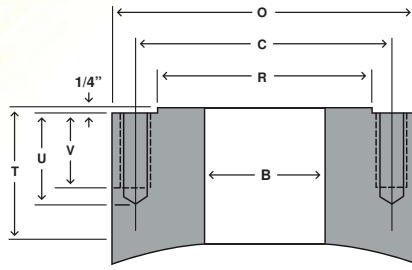

SHELL / HEAD MOUNT

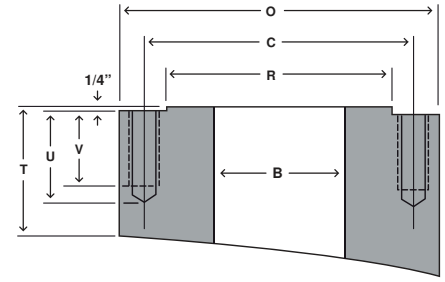

TANGENTIAL MOUNT

Bore	OD	Thickness	OD of RF	Stud Circle	Hole Dia	# of Holes	Hole Depth	Tap Size	T.P.I.	Tap Depth	Flat Bottom Weight	
B	O	T	R	C			U			V	Base	per 1"
1/2	4.75	2.00	1.38	3.25	21/32	4	1.31	3/4	10	0.88	8.2	5
3/4	5.12	2.00	1.69	3.50	21/32	4	1.31	3/4	10	0.88	10	5.7
1	5.88	2.12	2.00	4.00	49/64	4	1.44	7/8	9	1.00	14	7.5
1 1/4	6.25	2.12	2.50	4.38	49/64	4	1.44	7/8	9	1.00	15	8.3
1 1/2	7.00	2.25	2.88	4.88	7/8	4	1.56	1	8	1.12	20	10
2	8.50	2.12	3.62	6.50	49/64	8	1.44	7/8	9	1.00	27	15
2 1/2	9.62	2.25	4.12	7.50	7/8	8	1.56	1	8	1.12	37	19
3	9.50	2.12	5.00	7.50	49/64	8	1.44	7/8	9	1.00	33	18
4	11.50	2.50	6.19	9.25	1	8	1.81	1 1/8	8	1.25	56	26
5	13.75	2.75	7.31	11.00	1 1/8	8	2.12	1 1/4	8	1.44	87	37
6	15.00	2.50	8.50	12.50	1	12	1.81	1 1/8	8	1.25	91	42
8	18.50	3.00	10.62	15.50	1 1/4	12	2.25	1 3/8	8	1.56	162	62
10	21.50	3.00	12.75	18.50	1 1/4	16	2.25	1 3/8	8	1.56	210	81
12	24.00	3.00	15.00	21.00	1 1/4	20	2.25	1 3/8	8	1.56	251	96
14	25.25	3.25	16.25	22.00	1 3/8	20	2.38	1 1/2	8	1.69	275	98
16	27.75	3.50	18.50	24.25	1 1/2	20	2.56	1 5/8	8	1.88	348	114
18	31.00	3.88	21.00	27.00	1 3/4	20	3.00	1 7/8	8	2.12	473	142
20	33.75	4.25	23.00	29.50	1 7/8	20	3.31	2	8	2.25	608	164
24	41.00	5.12	27.25	35.50	2 3/8	20	4.00	2 1/2	8	2.81	1096	246

DIMENSIONS ARE IN INCHES | WEIGHTS ARE IN POUNDS

MATERIAL: Studding Outlets are most commonly provided in SA-105. they can also be made from a full range of stainless and alloy materials

THICKNESS: The standard thickness shown above for all studding outlets is the minimum required per ASME section V111 division 1 paragraph UG-43(d) for thread engagement and an ID mount. It is important to note that each individual application should be analyzed for proper thickness

FACING: The studding outlet minimum thickness "T" includes proper raised face per ANSI B16.5. Outlets can be supplied with any special facing as needed upon request.

DRILLING AND TAPPING: Studding outlets are furnished to ANSI B16.5 specifications unless otherwise specified. Thread depth is in accordance with ASME section V111 Division 1 Para. UG-43(g) for a design temperature not to exceed 650°F, a base metal stress of 17,500 psi (g), and a stud stress of 25,000 psi (g). All other materials exceeding these stresses should be checked for UG-43 compliance

BORE: Bore sizes shown above are standard. Other sizes can be furnished upon request

CURVING: All connections can be furnished contoured to fit any shell, head, or cone at an additional cost. Specify diameter to be mounted



Class 1500 Studding Outlets

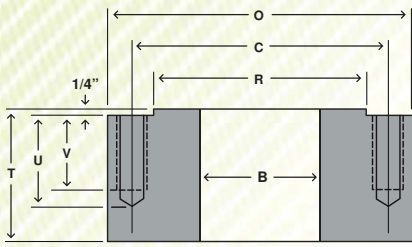

FLAT BOTTOM

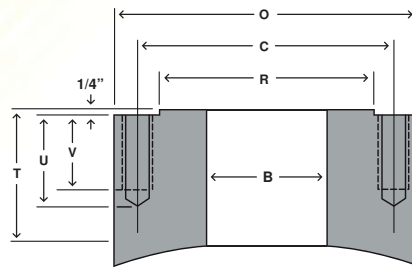

SHELL / HEAD MOUNT

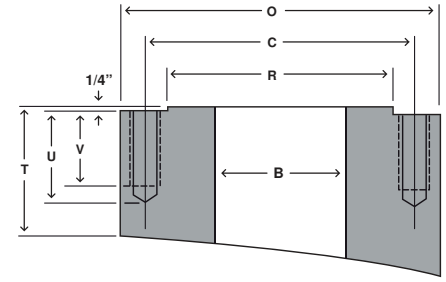

TANGENTIAL MOUNT

Bore Size	OD	Thickness	OD of RF	Stud Circle	Hole Dia	# of Holes	Hole Depth	Tap Size	T.P.I.	Tap Depth	Flat Bottom Weight	
B	O	T	R	C			U			V	Base	per 1"
1/2	4.75	2.00	1.38	3.25	21/32	4	1.31	3/4	10	0.88	8.2	5
3/4	5.12	2.00	1.69	3.50	21/32	4	1.31	3/4	10	0.88	10	5.7
1	5.88	2.12	2.00	4.00	49/64	4	1.44	7/8	9	1.00	14	7.5
1 1/4	6.25	2.12	2.50	4.38	49/64	4	1.44	7/8	9	1.00	15	8.3
1 1/2	7.00	2.25	2.88	4.88	7/8	4	1.56	1	8	1.12	20	10
2	8.50	2.12	3.62	6.50	49/64	8	1.44	7/8	9	1.00	27	15
2 1/2	9.62	2.25	4.12	7.50	7/8	8	1.56	1	8	1.12	37	19
3	10.50	2.50	5.00	8.00	1	8	1.81	1 1/8	8	1.25	48	23
4	12.25	2.75	6.19	9.50	1 1/8	8	2.12	1 1/4	8	1.44	70	30
5	14.75	3.12	7.31	11.50	1 3/8	8	2.38	1 1/2	8	1.69	114	43
6	15.50	3.00	8.50	12.50	1 1/4	12	2.25	1 3/8	8	1.56	116	45
8	19.00	3.50	10.62	15.50	1 1/2	12	2.56	1 5/8	8	1.88	224	66
10	23.00	3.88	12.75	19.00	1 3/4	12	3.00	1 7/8	8	2.12	345	95
12	26.50	4.12	15.00	22.50	1 7/8	16	3.31	2	8	2.25	456	124
14	29.50	4.25	16.25	25.00	2 1/8	16	3.56	2 1/4	8	2.56	540	150
16	32.50	5.00	18.50	27.75	2 3/8	16	4.00	2 1/2	8	2.81	762	178
18	36.00	5.50	21.00	30.50	2 5/8	16	4.38	2 3/4	8	3.12	1024	216
20	38.75	5.88	23.00	32.75	2 7/8	16	4.62	3	8	3.44	1234	245
24	46.00	6.75	27.25	39.00	3 3/8	16	5.38	3 1/2	8	4.00	1992	343

DIMENSIONS ARE IN INCHES / WEIGHTS ARE IN POUNDS

MATERIAL: Studding Outlets are most commonly provided in SA-105. they can also be made from a full range of stainless and alloy materials

THICKNESS: The standard thickness shown above for all studding outlets is the minimum required per ASME section V111 division 1 paragraph UG-43(d) for thread engagement and an ID mount. It is important to note that each individual application should be analyzed for proper thickness

FACING: The studding outlet minimum thickness "T" includes proper raised face per ANSI B16.5. Outlets can be supplied with any special facing as needed upon request.

DRILLING AND TAPPING: Studding outlets are furnished to ANSI B16.5 specifications unless otherwise specified. Thread depth is an accordance with ASME section V111 Division 1 Para. UG-43(g) for a design temperature not to exceed 650°F, a base metal stress of 17,500 psi(g), and a stud stress of 25,000 psi(g). All other materials exceeding these stresses should be checked for UG-43 compliance

BORE: Bore sizes shown above are standard. Other sizes can be furnished upon request

CURVING: All connections can be furnished contoured to fit any shell, head, or cone at an additional cost. Specify diameter to be mounted



Class 2500 Studding Outlets

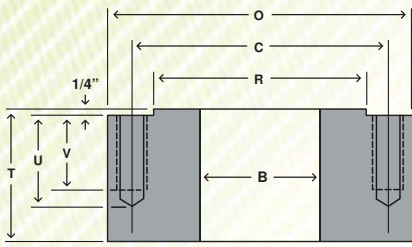

FLAT BOTTOM

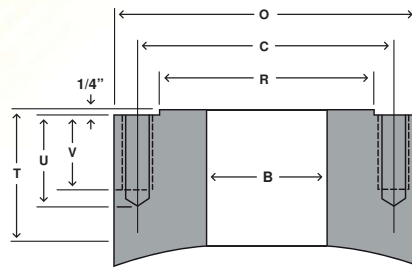

SHELL / HEAD MOUNT

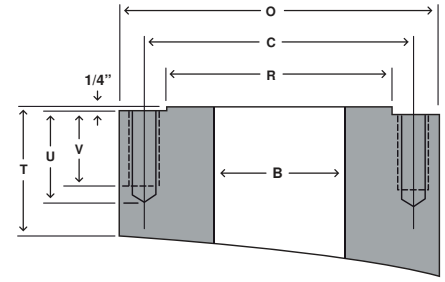

TANGENTIAL MOUNT

Bore Size	OD	Thickness	OD of RF	Stud Circle	Hole Dia	# of Holes	Hole Depth	Tap Size	T.P.I.	Tap Depth	Flat Bottom Weight	
B	O	T	R	C			U			V	Base	per 1"
1/2	5.25	2.00	1.38	3.50	21/32	4	1.31	3/4	10	0.88	10	6.1
3/4	5.50	2.00	1.69	3.75	21/32	4	1.31	3/4	10	0.88	11	6.6
1	6.25	2.12	2.00	4.25	49/64	4	1.44	7/8	9	1.00	15	8.5
1 1/4	7.25	2.25	2.50	5.12	7/8	4	1.56	1	8	1.12	22	11
1 1/2	8.00	2.50	2.88	5.75	1	4	1.81	1 1/8	8	1.25	29	14
2	9.25	2.25	3.62	6.75	7/8	8	1.56	1	8	1.12	34	18
2 1/2	10.50	2.50	4.12	7.75	1	8	1.81	1 1/8	8	1.25	49	23
3	12.00	2.75	5.00	9.00	1 1/8	8	2.12	1 1/4	8	1.44	71	30
4	14.00	3.25	6.19	10.75	1 3/8	8	2.38	1 1/2	8	1.69	112	40
5	16.50	3.75	7.31	12.75	1 5/8	8	2.81	1 3/4	8	2.00	179	55
6	19.00	4.12	8.50	14.50	1 7/8	8	3.31	2	8	2.25	259	72
8	21.75	4.38	10.62	17.25	1 7/8	12	3.31	2	8	2.25	345	91
10	26.50	5.12	12.75	21.25	2 3/8	12	4.00	2 1/2	8	2.81	590	134
12	30.00	5.50	15.00	24.38	2 5/8	12	4.38	2 3/4	8	3.12	799	168

DIMENSIONS ARE IN INCHES / WEIGHTS ARE IN POUNDS

MATERIAL: Studding Outlets are most commonly provided in SA-105. they can also be made from a full range of stainless and alloy materials

THICKNESS: The standard thickness shown above for all studding outlets is the minimum required per ASME section V111 division 1 paragraph UG-43(d) for thread engagement and an ID mount. It is important to note that each individual application should be analyzed for proper thickness

FACING: The studding outlet minimum thickness "T" includes proper raised face per ANSI B16.5. Outlets can be supplied with any special facing as needed upon request.

DRILLING AND TAPPING: Studding outlets are furnished to ANSI B16.5 specifications unless otherwise specified. Thread depth is in accordance with ASME section V111 Division 1 Para. UG-43(g) for a design temperature not to exceed 650°F, a base metal stress of 17,500 psi (g), and a stud stress of 25,000 psi (g). All other materials exceeding these stresses should be checked for UG-43 compliance

BORE: Bore sizes shown above are standard. Other sizes can be furnished upon request

CURVING: All connections can be furnished contoured to fit any shell, head, or cone at an additional cost. Specify diameter to be mounted



Line Blinds Class 150

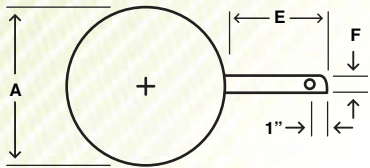

PADDLE BLANK TYPE 1

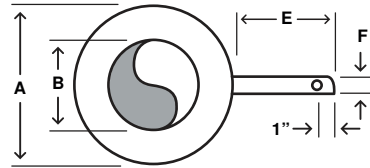

PADDLE SPACER TYPE 2

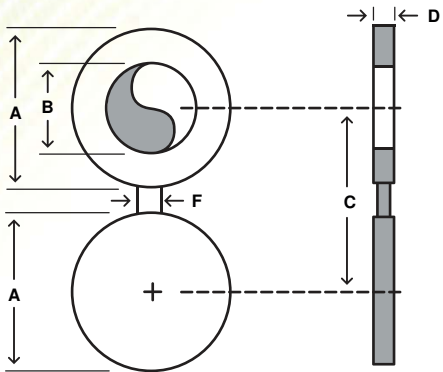

SPECTACLE BLIND TYPE 3

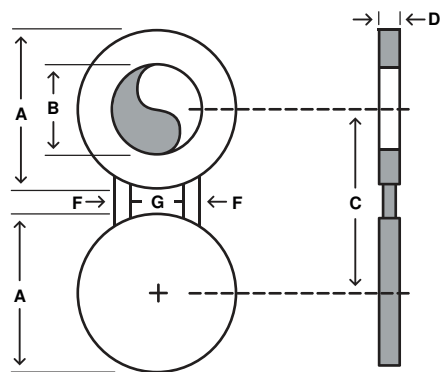

SPECTACLE BLIND TYPE 4

SIZE	A	B	C	D	E	F	G	Weights		
								1	2	3,4
1	2 1/2	1.05	3 1/8	1/4	4	1	1	1	1
1 1/2	3 1/4	1.90	3 7/8	1/4	4	1	1	1	1
2	4	2.38	4 3/4	1/4	4	1	2	1	2
2 1/2	4 3/4	2.88	5 1/2	1/4	4	1	2	2	3
3	5 1/4	3.50	6	1/4	4	1	2	2	3
4	6 3/4	4.50	7 1/2	3/8	4	1	3	2	5
6	8 5/8	6.62	9 1/2	1/2	4	1	7	4	10
8	10 7/8	8.62	11 3/4	1/2	4	1	14	7	20
10	13 1/4	10.75	14 1/4	5/8	5	1	26	12	35
12	16	12.75	17	3/4	5	1 1/2	45	21	62
14	17 1/2	14.00	18 3/4	3/4	5	1 1/2	53	24	74
16	20	16.00	21 1/4	7/8	5	1 1/2	1 1/2	92	40	127
18	21 3/8	18.00	22 3/4	1	5	1 1/2	1 1/2	105	39	139
20	23 5/8	20.00	25	1 1/8	5	1 1/2	1 1/2	145	50	188
24	28	24.00	29 1/2	1 1/4	5	1 1/2	1 1/2	245	80	315
30	34 1/2	30.00	36	1 5/8	5	1 1/2	1 1/2	437	128	555
36	41	36.00	42 3/4	2	6	1 1/2	1 3/4	757	203	945

*Based on ASME B16.48

DIMENSIONS ARE IN INCHES | WEIGHTS ARE IN POUNDS



Line Blinds Class 300

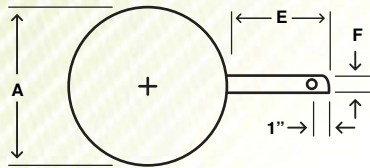

PADDLE BLANK TYPE 1

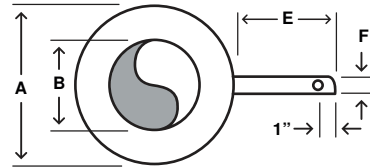

PADDLE SPACER TYPE 2

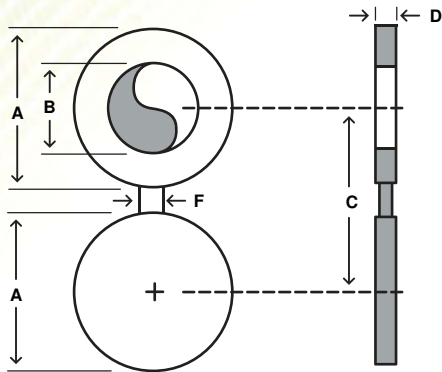

SPECTACLE BLIND TYPE 3

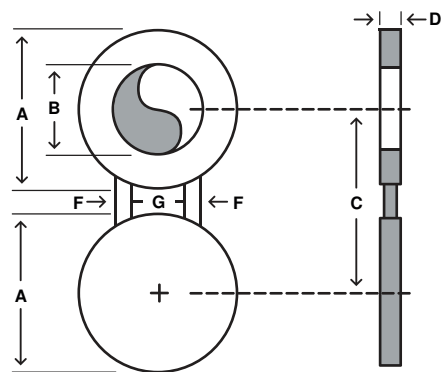

SPECTACLE BLIND TYPE 4

SIZE	A	B	C	D	E	F	G	Weights		
								1	2	3,4
1	2 3/4	1.05	3 1/2	1/4	4	1	1	1	1
1 1/2	3 5/8	1.90	4 1/2	1/4	4	1	1	1	2
2	4 1/4	2.38	5	3/8	4	1	2	1	2
2 1/2	5	2.88	5 7/8	3/8	4	1	3	2	4
3	5 3/4	3.50	6 5/8	3/8	4	1	3	3	4
4	7	4.50	7 7/8	1/2	4	1	7	5	10
6	9 3/4	6.62	10 5/8	5/8	4	1	15	10	22
8	12	8.62	13	7/8	4	1	26	15	38
10	14 1/8	10.75	15 1/4	1	5	1	47	25	67
12	16 1/2	12.75	17 3/4	1 1/4	5	1 1/2	1 1/2	79	39	113
14	18 7/8	14.00	20 1/4	1 1/4	5	1 1/2	1 1/2	103	54	150
16	21	16.00	22 1/2	1 1/2	5	1 1/2	1 1/2	151	74	218
18	23 1/4	18.00	24 3/4	1 5/8	5	1 1/2	1 1/2	200	92	285
20	25 1/2	20.00	27	1 7/8	6	1 1/2	1 1/2	280	124	390
24	30 1/4	24.00	32	2	6	1 1/2	1 1/2	470	200	650
30	37 1/4	30.00	39 1/4	2 5/8	6	1 1/2	1 1/2	860	340	1190

*Based on ASME B16.48

DIMENSIONS ARE IN INCHES | WEIGHTS ARE IN POUNDS



Line Blinds Class 600

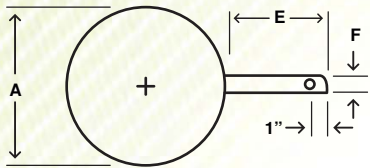

PADDLE BLANK TYPE 1

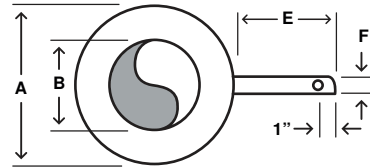

PADDLE SPACER TYPE 2

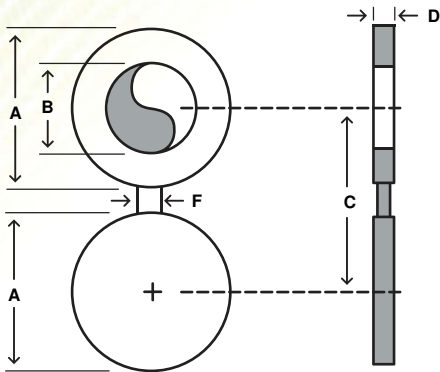

SPECTACLE BLIND TYPE 3

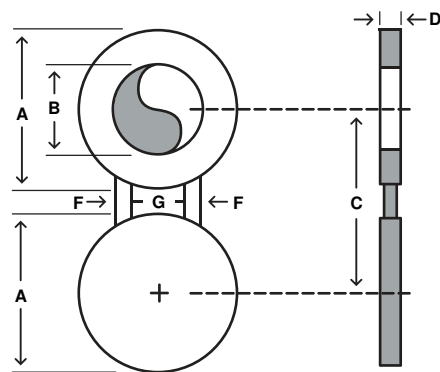

SPECTACLE BLIND TYPE 4

SIZE	A	B	C	D	E	F	G	Weights		
								1	2	3,4
1	2 3/4	1.50	3 1/2	1/4	4	1	1	1	1
1 1/2	3 5/8	1.68	4 1/2	3/8	4	1	1	1	2
2	4 1/4	2.16	5	3/8	4	1	2	1	3
2 1/2	5	2.64	5 7/8	1/2	4	1	3	2	4
3	5 3/4	3.26	6 5/8	1/2	4	1	5	4	7
4	7 1/2	4.26	8 1/2	5/8	4	1	9	7	14
6	10 3/8	6.36	11 1/2	7/8	4	1	23	17	36
8	12 1/2	8.33	13 3/4	1 1/8	4	1	42	27	65
10	15 5/8	10.42	17	1 3/8	5	1 1/2	1 1/2	85	53	132
12	17 3/4	12.39	19 1/4	1 5/8	5	1 1/2	1 1/2	127	73	193
14	19 1/8	13.62	20 3/4	1 3/4	5	1 1/2	1 3/4	147	79	218
16	22	15.62	23 3/4	2	5	1 1/2	1 3/4	237	140	365
18	23 7/8	17.62	25 3/4	2 1/8	5	1 1/2	2	310	153	450
20	26 5/8	19.56	28 1/2	2 1/2	6	1 1/2	2	405	235	625
24	30 7/8	23.50	33	2 7/8	6	1 1/2	2 1/4	645	335	970

*Based on ASME B16.48

DIMENSIONS ARE IN INCHES | WEIGHTS ARE IN POUNDS



Line Blinds Class 900

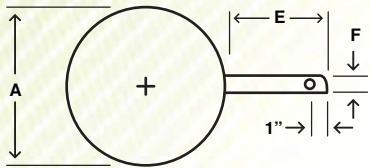

PADDLE BLANK TYPE 1

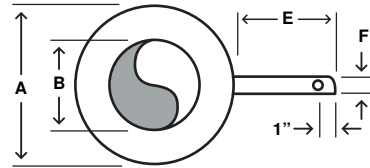

PADDLE SPACER TYPE 2

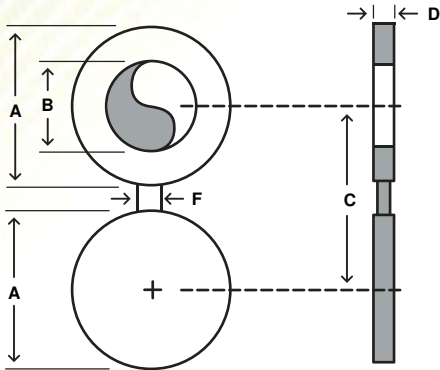

SPECTACLE BLIND TYPE 3

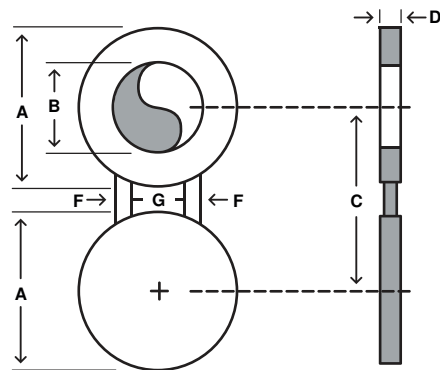

SPECTACLE BLIND TYPE 4

SIZE	A	B	C	D	E	F	G	Weights		
								1	2	3,4
1	3	1.05	4	1/4	5	1	1	1	1
1 1/2	3 3/4	1.68	4 7/8	3/8	5	1	2	2	2
2	5 1/2	2.16	6 1/2	1/2	5	1	3	3	5
2 1/2	6 3/8	2.64	7 1/2	1/2	5	1	6	5	9
3	6 1/2	3.26	7 1/2	5/8	5	1	8	7	11
4	8	4.26	9 1/4	3/4	5	1	13	11	20
6	11 1/4	6.36	12 1/2	1	5	1	35	28	58
8	14	8.33	15 1/2	1 3/8	5	1	1 1/2	63	49	107
10	17	10.42	18 1/2	1 5/8	5	1 1/2	1 1/2	117	89	200
12	19 3/8	12.39	21	1 7/8	5	1 1/2	1 1/2	172	127	290
14	20 1/4	13.62	22	2 1/8	6	1 1/2	1 3/4	212	150	350
16	22 3/8	15.62	24 1/4	2 3/8	6	1 1/2	1 3/4	286	196	468
18	24 7/8	17.62	27	2 5/8	6	1 1/2	2	407	275	665

*Based on ASME B16.48

DIMENSIONS ARE IN INCHES | WEIGHTS ARE IN POUNDS



1/2"–24"–COVERED BY ANSI B16.5

QUANTITY

SIZE *(nominal pipe size)*

PRESSURE CLASS *(150–2500)*

FACING *(RF, FF, RTJ, ect.)*

TYPE *(WN, SO, Threaded, Blind, SW, LJ)*

BORE *(if SW or WN)*

MATERIAL

E.G. 2–4" 300# RFWN STD 304

26"–60" COVERED BY ANSI B16.47–WN AND BLINDS ONLY

QUANTITY

SIZE *(nominal pipe size)*

PRESSURE CLASS

FACING

TYPE

BORE *(if WN)*

SERIES

MATERIAL

E.G. 2–36" 300# RF BLIND SER A 304

SLIP—ONS LARGER THAN 24"

INDUSTRY STANDARD 125LW, 125 / 150, CLASS 250

BOILER CODE CLASS 75, 175, 350

B16.47 SER A DIMENSIONS PER TUBE TURN

B16.47 SER B DIMENSIONS WITH 1" HUB *(slightly tapered)*

E.G. 30" 150# RFSO SERIES A PER TT A105

AWWA FLANGES

QUANTITY

SIZE *(nominal pipe size)*

CLASS *(B, D, E, F)*

TYPE *(ring, hub, blind)*

MATERIAL *(if not standard steel)*

E.G. 3–30" CLASS D RING 316

Wall Thickness

Nom Pipe Size	OD	NOMINAL WALL THICKNESS												
		Sch 10	Sch 20	Sch 30	STD Wall	Sch 40	Sch 60	EXT Hvy	Sch 80	Sch 100	Sch 120	Sch 140	Sch 160	XX Hvy
1/2	0.840	0.083	0.109	0.109	0.147	0.147	0.188	0.294
3/4	1.050	0.083	0.113	0.113	0.154	0.154	0.219	0.308
1	1.315	0.109	0.133	0.133	0.179	0.179	0.250	0.358
1 1/4	1.660	0.109	0.140	0.140	0.191	0.191	0.250	0.382
1 1/2	1.900	0.109	0.145	0.145	0.200	0.200	0.281	0.400
2	2.375	0.109	0.154	0.154	0.218	0.218	0.344	0.436
2 1/2	2.875	0.120	0.203	0.203	0.276	0.276	0.375	0.552
3	3.500	0.120	0.216	0.216	0.300	0.300	0.438	0.600
3 1/2	4.000	0.120	0.226	0.226	0.318	0.318	0.636
4	4.500	0.120	0.237	0.237	0.337	0.337	0.438	0.531	0.674
5	5.563	0.134	0.258	0.258	0.375	0.375	0.500	0.625	0.750
6	6.625	0.134	0.280	0.280	0.432	0.432	0.562	0.719	0.864
8	8.625	0.148	0.250	0.277	0.322	0.322	0.406	0.500	0.500	0.594	0.719	0.812	0.906	0.875
10	10.750	0.165	0.250	0.307	0.365	0.365	0.500	0.500	0.594	0.719	0.844	1.000	1.125	1.000
12	12.750	0.180	0.250	0.330	0.375	0.406	0.562	0.500	0.688	0.844	1.000	1.125	1.312	1.000
14	14.000	0.250	0.312	0.375	0.375	0.438	0.594	0.500	0.750	0.938	1.094	1.250	1.406
16	16.000	0.250	0.312	0.375	0.375	0.500	0.656	0.500	0.844	1.031	1.219	1.438	1.594
18	18.000	0.250	0.312	0.438	0.375	0.562	0.750	0.500	0.938	1.156	1.375	1.562	1.781
20	20.000	0.250	0.375	0.500	0.375	0.594	0.812	0.500	1.031	1.281	1.500	1.750	1.969
22	22.000	0.250	0.375	0.500
24	24.000	0.250	0.375	0.562	0.375	0.688	0.969	0.500	1.219	1.531	1.812	2.062	2.344
26	26.000	0.375	0.500
30	30.000	0.312	0.500	0.625	0.375	0.500
36	36.000	0.312	0.500	0.625	0.375	0.750	0.500
40	40.000	0.375	0.500
42	42.000	0.375	0.500
48	48.000	0.375	0.500

DIMENSIONS ARE IN INCHES

- (1) Light wall thicknesses are identical to stainless steel Schedule 10S in sizes through 12", and to Schedule 10 sizes 14" and larger
- (2) Standard wall thicknesses are identical to stainless steel Schedule 40S in sizes through 10"
- (3) Extra heavy wall thicknesses are identical to stainless steel schedule 80S in sizes through 8"
- (4) Other types, sizes, and thicknesses of flanges can be provided to meet application
- (5) Stocked and manufactured in carbon steel, stainless steel, and variety of other metals and alloys
- (6) Inside pipe diameters are provided on the following page



Weld Neck Flange Bores

Nom Pipe Size	OD	NOMINAL BORE												
		Sch 10	Sch 20	Sch 30	STD Wall	Sch 40	Sch 60	EXT Hvy	Sch 80	Sch 100	Sch 120	Sch 140	Sch 160	XX Hvy
1/2	0.840	0.674	0.622	0.622	0.546	0.546	0.464	0.252
3/4	1.050	0.884	0.824	0.824	0.742	0.742	0.612	0.434
1	1.315	1.097	1.049	1.049	0.957	0.957	0.815	0.599
1 1/4	1.660	1.442	1.380	1.380	1.278	1.278	1.160	0.896
1 1/2	1.900	1.682	1.610	1.610	1.500	1.500	1.338	1.100
2	2.375	2.157	2.067	2.067	1.939	1.939	1.687	1.503
2 1/2	2.875	2.635	2.469	2.469	2.323	2.323	2.125	1.771
3	3.500	3.260	3.068	3.068	2.900	2.900	2.624	2.300
3 1/2	4.000	3.760	3.548	3.548	3.364	3.364	2.728
4	4.500	4.260	4.026	4.026	3.826	3.826	3.624	3.438	3.152
5	5.563	5.295	5.047	5.047	4.813	4.813	4.563	4.313	4.063
6	6.625	6.357	6.065	6.065	5.761	5.761	5.501	5.187	4.897
8	8.625	8.329	8.125	8.071	7.981	7.981	7.813	7.625	7.625	7.437	7.187	7.001	6.813	6.875
10	10.750	10.420	10.250	10.136	10.020	10.020	9.750	9.750	9.562	9.312	9.062	8.750	8.500	8.750
12	12.750	12.390	12.250	12.090	12.000	11.938	11.626	11.750	11.374	11.062	10.750	10.500	10.126	10.750
14	14.000	13.500	13.376	13.250	13.250	13.124	12.812	13.000	12.500	12.124	11.812	11.500	11.188
16	16.000	15.500	15.376	15.250	15.250	15.000	14.688	15.000	14.312	13.938	13.562	13.124	12.812
18	18.000	17.500	17.376	17.124	17.250	16.876	16.500	17.000	16.124	15.688	15.250	14.876	14.438
20	20.000	19.500	19.250	19.000	19.250	18.812	18.376	19.000	17.938	17.438	17.000	16.500	16.062
22	22.000	21.500	21.250	21.000
24	24.000	23.500	23.250	22.876	23.250	22.624	22.062	23.000	21.562	20.938	20.376	19.876	19.312
26	26.000	25.250	25.000
30	30.000	29.376	29.000	28.750	29.250	29.000
36	36.000	35.376	35.000	34.750	35.250	34.500	35.000
40	40.000	39.250	39.000
42	42.000	41.250	41.000
48	48.000	47.250	47.000

DIMENSIONS ARE IN INCHES

- (1) Source: ANSI B36.10
- (2) These dimensions are the same for inside pipe diameter. **ALWAYS** specify bore when ordering
- (3) Other type, sizes, and thicknesses of flanges can be provided to meet application
- (4) Stocked and manufactured in carbon steel, stainless steel, and a variety of other metals and alloys
- (5) Wall thicknesses are provided on the previous page



Dimensions of Ring—Joint Facings

TOLERANCES

E(depth)	+0.016 -0
F(width)	±0.008
P(pitch diam)	±0.005
R(radius at bottom)	max
23° (angle)	±1/2°

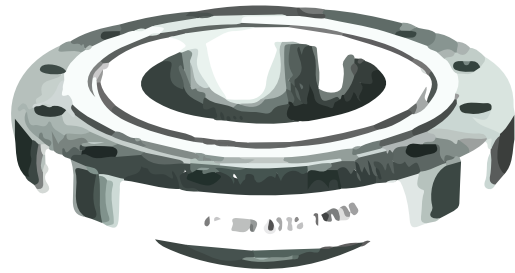

Nominal Pipe Size							Groove Dimensions					Diameter of Raised Portion K					
150 PSI	300 PSI	400 PSI	600 PSI	900 PSI	1500 PSI	2500 PSI	Groove #	Pitch Dia	Depth	Width	Radius at Bottom	150 PSI	300 400 600 PSI	900 PSI	1500 PSI	2500 PSI	Depth
								P	E	F	R						E
.....	1/2	1/2	R11	1-11/32	7/32	9/32	1/32	2	7/32
.....	1/2	12	1-9/16	1/4	11/32	1/32	2-3/8	2-3/8	1/4
.....	3/4	3/4	1/2	13	1-11/16	1/4	11/32	1/32	2-1/2	2-9/16	1/4
.....	3/4	14	1-3/4	1/4	11/32	1/32	2-5/8	2-5/8	1/4
1	15	1-7/8	1/4	11/32	1/32	2-1/2	1/4
.....	1	1	1	3/4	16	2	1/4	11/32	1/32	2-3/4	2-13/16	2-13/16	2-7/8	1/4
1-1/4	17	2-1/4	1/4	11/32	1/32	2-7/8	1/4
.....	1-1/4	1-1/4	1-1/4	1	18	2-3/8	1/4	11/32	1/32	3-1/8	3-3/16	3-3/16	3-1/4	1/4
1-1/2	19	2-9/16	1/4	11/32	1/32	3-1/4	1/4
.....	1-1/2	1-1/2	1-1/2	20	2-11/16	1/4	11/32	1/32	3-9/16	3-5/8	3-5/8	1/4
.....	1-1/4	21	2-27/32	5/16	15/32	1/32	4	5/16
2	22	3-1/4	1/4	11/32	1/32	4	1/4
.....	2	2	1-1/2	23	3-1/4	5/16	15/32	1/32	4-1/4	4-1/2	5/16
.....	2	24	3-3/4	5/16	15/32	1/32	4-7/8	4-7/8	5/16
2-1/2	25	4	1/4	11/32	1/32	4-3/4	1/4
.....	2-1/2	2-1/2	2	26	4	5/16	15/32	1/32	5	5/16
.....	2-1/2	27	4-1/4	5/16	15/32	1/32	5-3/8	5/16
.....	2-1/2	28	4-3/8	3/8	17/32	1/16	5-7/8	3/8
3	29	4-1/2	1/4	11/32	1/32	5-1/4	1/4
.....	30	4-5/8	5/16	15/32	1/32	5/16
.....	3	3	3	31	4-7/8	5/16	15/32	1/32	5-3/4	6-1/8	5/16
.....	3	32	5	3/8	17/32	1/16	6-5/8	3/8
3-1/2	33	5-3/16	1/4	11/32	1/32	6-1/16	1/4
.....	3-1/2	3-1/2	34	5-3/16	5/16	15/32	1/32	6-1/4	5/16
.....	3	35	5-3/8	5/16	15/32	1/32	6-5/8	5/16
4	36	5-7/8	1/4	11/32	1/32	6-3/4	1/4
.....	4	4	4	4	37	5-7/8	5/16	15/32	1/32	6-7/8	7-1/8	5/16
.....	4	38	6-3/16	7/16	21/32	1/16	8	7/16
.....	4	39	6-3/8	5/16	15/32	1/32	7-5/8	5/16
5	40	6-3/4	1/4	11/32	1/32	7-5/8	1/4
.....	5	5	5	5	41	7-1/8	5/16	15/32	1/32	8-1/4	8-1/2	5/16
.....	5	42	7-1/2	1/2	25/32	1/16	9-1/2	1/2
6	43	7-5/8	1/4	11/32	1/32	8-5/8	1/4
.....	5	44	7-5/8	5/16	15/32	1/32	9	5/16
.....	6	6	6	6	45	8-5/16	5/16	15/32	1/32	9-1/2	9-1/2	5/16

DIMENSIONS ARE IN INCHES / RAISED FACE HEIGHT MATCHES DEPTH OF GROOVE



Dimensions of Ring—Joint Facings

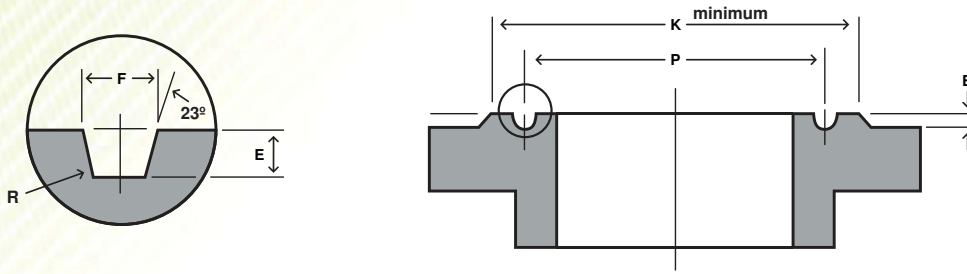

Nominal Pipe Size							Groove Dimensions					Diameter of Raised Portion K					
150 PSI	300 PSI	400 PSI	600 PSI	900 PSI	1500 PSI	2500 PSI	Groove #	Pitch Dia	Depth	Width	Radius at Bottom	150 PSI	300 400 600 PSI	900 PSI	1500 PSI	2500 PSI	Depth
								P	E	F	R						E
					6		R46	8-5/16	3/8	17/32	1/16				9-3/4		3/8
						6	47	9	1/2	25/32	1/16					11	1/2
8							48	9-3/4	1/4	11/32	1/32	10-3/4					1/4
	8	8	8	8			49	10-5/8	5/16	15/32	1/32	11-7/8	12-1/8				5/16
					8		50	10-5/8	7/16	21/32	1/16				12-1/2		7/16
						8	51	11	9/16	29/32	1/16					13-3/8	9/16
10							52	12	1/4	11/32	1/32	13					1/4
	10	10	10	10			53	12-3/4	5/16	15/32	1/32	14	14-1/4				5/16
					10		54	12-3/4	7/16	21/32	1/16				14-5/8		7/16
						10	55	13-1/2	11/16	1-3/16	3/32					16-3/4	11/16
12							56	15	1/4	11/32	1/32	16					1/4
	12	12	12	12			57	15	5/16	15/32	1/32	16-1/4	16-1/2				5/16
					12		58	15	9/16	29/32	1/16				17-1/4		9/16
14							59	15-5/8	1/4	11/32	1/32	16-3/4					1/4
						12	60	16	11/16	1-5/16	3/32					19-1/2	11/16
	14	14	14				61	16-1/2	5/16	15/32	1/32	18					5/16
					14		62	16-1/2	7/16	21/32	1/16				18-3/8		7/16
						14	63	16-1/2	5/8	1-1/16	3/32				19-1/4		5/8
16							64	17-7/8	1/4	11/32	1/32	19					1/4
	16	16	16				65	18-1/2	5/16	15/32	1/32	20					5/16
					16		66	18-1/2	7/16	21/32	1/16				20-5/8		7/16
						16	67	18-1/2	11/16	1-3/16	3/32				21-1/2		11/16
18							68	20-3/8	1/4	11/32	1/32	21-1/2					1/4
	18	18	18				69	21	5/16	15/32	1/32	22-5/8					5/16
					18		70	21	1/2	25/32	1/16				23-3/8		1/2
						18	71	21	11/16	1-3/16	3/32				24-1/8		11/16
20							72	22	1/4	11/32	1/32	23-1/2					1/4
	20	20	20				73	23	3/8	17/32	1/16	25					3/8
					20		74	23	1/2	25/32	1/16				25-1/2		1/2
						20	75	23	11/16	1-5/16	3/32			—	26-1/2		11/16
24							76	26-1/2	1/4	11/32	1/32	28					1/4
	24	24	24				77	27-1/4	7/16	21/32	1/16	29-1/2					7/16
					24		78	27-1/4	5/8	1-1/16	3/32				30-3/8		5/8
						24	79	27-1/4	13/16	17/16	3/32				31-1/4		13/16

DIMENSIONS ARE IN INCHES / RAISED FACE HEIGHT MATCHES DEPTH OF GROOVE



Alternate Flange Facings

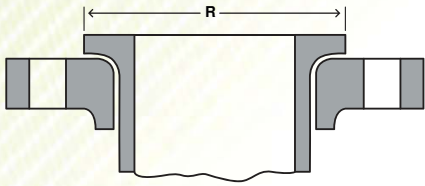

LAP JOINT

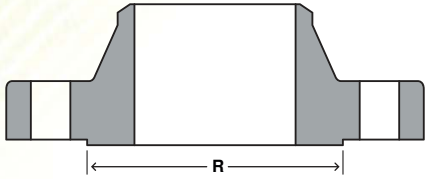

RAISED FACE

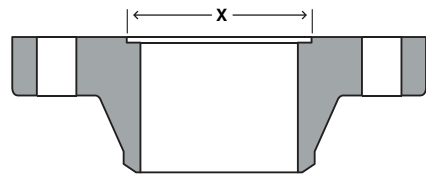
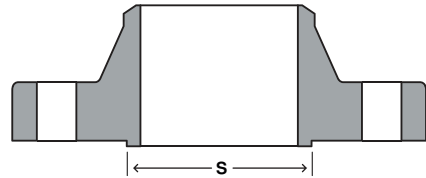

SMALL MALE & FEMALE

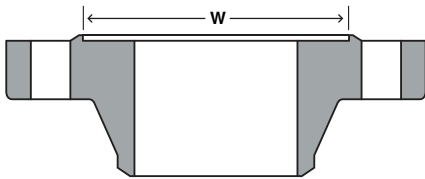
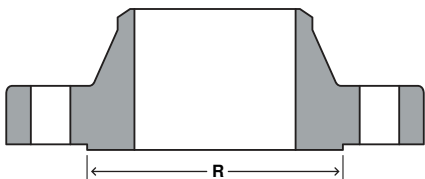

LARGE MALE & FEMALE

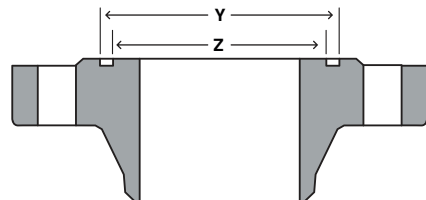
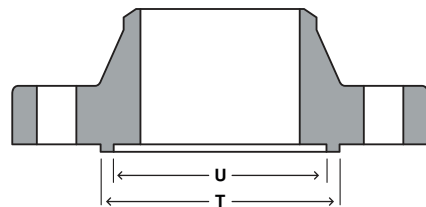

SMALL TONGUE & GROOVE

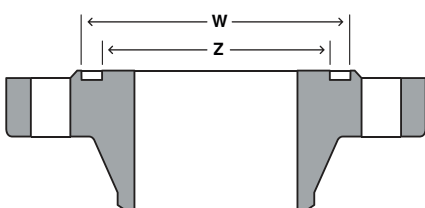
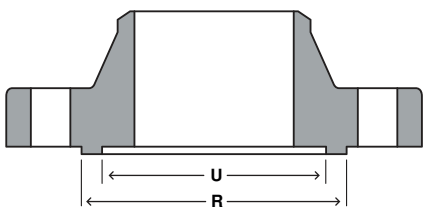

LARGE TONGUE & GROOVE

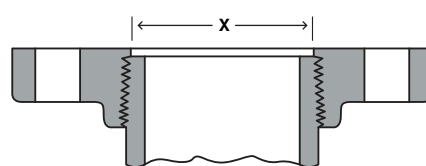
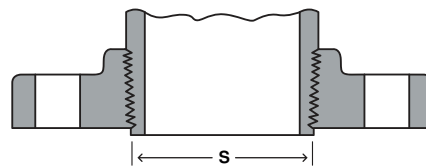

SMALL MALE & FEMALE
ON END OF PIPE



Alternate Flange Facings For 150 | 300 | 400 | 600 | 900 | 1500 | 2500 LB FLANGES

Nominal Size (in.)	RF, LJ, Large Male and Large Tongue	Small Male (3)	Small Tongue	ID of Large and Small Tongue	Large Female and Large Groove	Small Female (3)	Small Groove	ID of Large and Small Groove	Raised Face 150 and 300 Pound Standards (2)	RF, Large and Small Male and Tongue 400, 600, 900, 1500, & 2500 lb. Standards (2)	Depth of Groove or Female
	R	S	T	U	W	X	Y	Z			
1/2	1.38	0.72	1.38	1.00	1.44	0.78	1.44	0.94	0.06	0.25	0.19
3/4	1.69	0.94	1.69	1.31	1.75	1.00	1.75	1.25	0.06	0.25	0.19
1	2.00	1.19	1.88	1.50	2.06	1.25	1.94	1.44	0.06	0.25	0.19
1 1/4	2.50	1.50	2.25	1.88	2.56	1.56	2.31	1.81	0.06	0.25	0.19
1 1/2	2.88	1.75	2.50	2.12	2.94	1.81	2.56	2.06	0.06	0.25	0.19
2	3.62	2.25	3.25	2.88	3.69	2.31	3.31	2.81	0.06	0.25	0.19
2 1/2	4.12	2.69	3.75	3.38	4.19	2.75	3.81	3.31	0.06	0.25	0.19
3	5.00	3.31	4.62	4.25	5.06	3.38	4.69	4.19	0.06	0.25	0.19
3 1/2	5.50	3.81	5.12	4.75	5.56	3.88	5.19	4.69	0.06	0.25	0.19
4	6.19	4.31	5.69	5.19	6.25	4.38	5.75	5.12	0.06	0.25	0.19
5	7.31	5.38	6.81	6.31	7.38	5.44	6.88	6.25	0.06	0.25	0.19
6	8.50	6.38	8.00	7.50	8.56	6.44	8.06	7.44	0.06	0.25	0.19
8	10.62	8.38	10.00	9.38	10.69	8.44	10.06	9.31	0.06	0.25	0.19
10	12.75	10.50	12.00	11.25	12.81	10.56	12.06	11.19	0.06	0.25	0.19
12	15.00	12.50	14.25	13.50	15.06	12.56	14.31	13.44	0.06	0.25	0.19
14	16.25	13.75	15.50	14.75	16.31	13.81	15.56	14.69	0.06	0.25	0.19
16	18.50	15.75	17.62	16.75	18.56	15.81	17.69	16.69	0.06	0.25	0.19
18	21.00	17.75	20.12	19.25	21.06	17.81	20.19	19.19	0.06	0.25	0.19
20	23.00	19.75	22.00	21.00	23.06	19.81	22.06	20.94	0.06	0.25	0.19
24	27.25	23.75	26.25	25.25	27.31	23.81	26.31	25.19	0.06	0.25	0.19

[1] Regular facing for 150 and 300 lb. steel flanged fittings and flange standards is a 1/16" raised face included in the minimum flange thickness. A 1/16" raised face is also permitted on the 400, 600, 900, 1500, and 2500 lb. flange standards, but it must be added to the minimum flange thickness

[2] Regular facing for 400, 600, 900, 1500, and 2500 lb. flange standards is a 1/4" raised face not included in minimum flange thickness dimensions

[3] Care should be taken in the use of joints of these dimensions (they apply particularly on lines where the joint is made on the end of the pipe) to insure that pipe used is thick enough to permit sufficient bearing surface to prevent crushing the gasket. Threaded companion flanges are furnished with plain face and are threaded with American Standard Locknut Thread

[4] Dimensions shown are consistent with specifications predating the 1990's. Alternate face connections are typically supplied to meet older designs. Please specify if your requirements dictate otherwise



TEXAS FLANGE

PRODUCT CATALOG: VER 5.00

WWW.TEXASFLANGE.COM
SALES@TEXASFLANGE.COM

LOCAL

P 281.484.8325

F 281.484.8730

NATIONAL

P 800.826.3801

F 877.610.8893

